



*X*series

**AC-DC**  
TIG Welder

**INVERTER TIG/MMA  
WELDER MANUAL**

**200X**



**BOSSWELD** *X*series  
WELD LIKE A BOSS

## Thank you for choosing a AC/DC 200X INVERTER AC DC TIG WELDER

In this manual you will find instructions on how to set up your welder along with general welding information, safety information and helpful tips. We encourage you to go online to our website for more tips and troubleshooting as well as many welding resources.

The BOSSWELD AC/DC 200X is the latest in IGBT inverter welder technology, this precise power source delivers a smooth output in AC and DC Lift TIG, HF TIG, MMA/Stick settings, providing the user adjustments via the full digital control. A perfect choice for the astute tradesman, or serious welding hobbyist wanting to tackle Aluminium TIG welding.

We truly hope you enjoy using your welder!

**T**

### TIG

- Gives a better weld finish
- Accurate heat control
- Considered the most challenging process to learn
- Good way to weld thin material
- Argon gas is required

#### METAL TYPES

Mild steel, stainless steel & aluminium

**S**

### STICK

- Easiest process to learn
- Best choice for quick repairs
- Slower than MIG welding
- Forgiving in dirty/rusty environments
- Not recommended for thin sheet metal welding

#### METAL TYPES

Mild steel, stainless steel & cast iron

<b>CONTENTS</b>	<b>PAGE</b>
WARRANTY	4
BOX CONTENTS	5
WARNINGS	6
MACHINE CARE / SAFETY INSTRUCTIONS	7
WORK AREA SAFETY	8
MAINTENANCE & DISPOSAL / GAS BOTTLE	9
FRONT & REAR PANEL LAYOUT	10
MACHINE CONTROLS PANEL	11-12
DUTY CYCLE	13
GENERAL AC/DC WELDING	14
GENERAL PULSE WELDING	15
GENERAL 2T / 4T TRIGGER CONTROL	16
GENERAL LIFT ARC / HF START	16-17
FOOT CONTROL UPGRADE OPTIONS	17
STICK / MMA WELDING SETUP	18-19
ELECTRODE / CURRENT SELECTION	20
GENERAL MMA WELDING	21
TIG WELDING SETUP	22-23
AC/DC WELD CYCLE SETUP	24-26
TUNGSTEN PREPERATION / TIG WELDING	27
TIG WELDING CONTINUED	28
26 TIG TORCH BREAKDOWN	29
TROUBLE SHOOTING	30-31



## WARRANTY

This warranty is in addition to the statutory warranty provided under Australian Consumer Law, but does not include damage resulting from transport, misuse, neglect or if the product has been tampered with. The product must be maintained as per this manual, and installed and used according to these instructions on an appropriate power supply. The product must be used in accordance with industry standards and acceptable practice.

This warranty covers the materials used to manufacture the machine and the workmanship used to produce the item. This Warranty does not cover damage caused by:

1. Normal wear and tear due to usage
2. Misuse /abuse or Neglect of the item
3. Transport / handling breakages
4. Lack of maintenance, care and cleaning
5. Environmental factors, such as usage in temperatures exceeding 40 degrees, above 1000mt sea level, rain, water, excessive damp, cold or humid conditions.
6. Improper setup or installation
7. Use on Incorrect voltage or non authorised electrical connections and plugs
8. Use of non standard parts
9. Repair, case opening, tampering with, modifications to any part of the item by non authorised BOSSWELD repairers.

This warranty covers the machine only and does not include Torches, Leads, Earth Clamps, Electrode holders, Plasma Torches, Tig Torches and any of the parts on those items unless there is a manufacturing fault.

### 1. REGISTRATION

Purchasers are encouraged to register for warranty on our website. [www.bossweld.com.au/warranty](http://www.bossweld.com.au/warranty)

### 2. TIME PERIOD - 3 Years

A warranty claim must be made within 3 years from the date of purchase of this product. Any claim must include proof of purchase.

### 3. HOW TO MAKE A CLAIM - NEED SOME HELP?

- Visit our website [www.bossweld.com.au/troubleshooting](http://www.bossweld.com.au/troubleshooting) for many helpful tips and guides to assist with the setup and usage of your new machine. Still stuck....?
- Call the BOSSWELD Helpdesk on 1300 460 665 for over the phone assistance.
- If the machine is not operational then return the item to the place of purchase.

**BOSSWELD MAKES NO OTHER WARRANTY, EXPRESS OR IMPLIED. THIS WARRANTY IS EXCLUSIVE AND IN LIEU OF ALL OTHERS, INCLUDING, BUT NOT LIMITED TO ANY WARRANTY OF MERCHANTABILITY OR FITNESS FOR ANY PARTICULAR PURPOSE.**



**DO NOT GRIND YOUR PLUG**  
This will void any warranty on your machine

## BOSSWELD AC/DC 200X Inverter TIG Welder Box Contents

1. AC/DC 200X Inverter TIG / MMA Welder
2. 4m 26 Series TIG Torch
3. Electrode Holder Lead
4. Welding Earth Lead
5. Gas Hose
6. Carry Strap
7. Dual Stage Argon Regulator
8. Torch Spares (not shown)
9. Owners Manual (not shown)

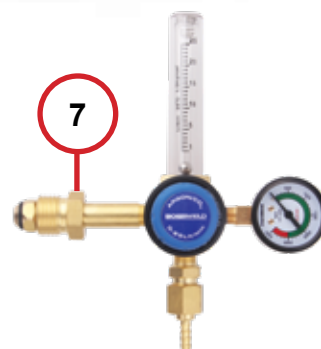
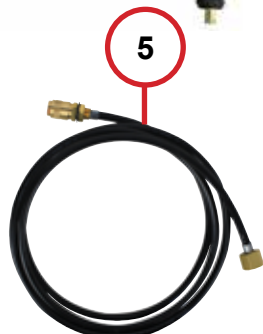



## WARNING

The device and packaging material are not toys! Children must not be allowed to play with the machine and its accessories. Plastic parts and packaging are choking risks for children.

- Open the packaging and remove the welder carefully.
- Check that the delivery is complete.
- If possible, store the packaging until the warranty period has expired.

## PERSONAL PROTECTIVE EQUIPMENT (PPE)



### GLOVES AND PROTECTIVE CLOTHING

Use protective gloves and fire resistant protective clothing when welding. Avoid exposing skin to ultraviolet rays produced by the arc.



### WELDING HELMET

Under no circumstances should the welder be operated unless the operator is wearing a welding helmet to protect the eyes and face. There is serious risk of eye damage if a helmet is not used. The sparks and metal projectiles can cause serious damage to the eyes and face. The light radiation produced by the arc can cause damage to eyesight, and burns to skin. Never remove the welding helmet whilst welding.



### SAFETY GLASSES

After welding use appropriate safety glasses when brushing, chipping or grinding the slag from the weld.



### OTHER PERSONS

Ensure that other persons are screened from the welding arc and are at least 15 metres away from the work piece. Always ensure that the welding arc is screened from onlookers, or people just passing by. Use screens if necessary, or non-reflecting welding curtain. Do not let children or animals have access to the welding equipment or to the work area.



### SWITCHING OFF

When the operator has finished welding they must switch the welder off. DO NOT put the electrode holder down with the welder switched ON. When leaving the welder unattended, move the ON/OFF switch to the OFF position and disconnect the welder from the electrical mains supply. Do not leave hot material unattended after welding.



### FUMES & GASES ARE DANGEROUS

Smoke and gas generated whilst welding or cutting can be harmful to people's health. Welding produces fumes and gases. Breathing these fumes and gases can be hazardous to your health.

- Do not breathe the smoke and gas generated whilst welding or cutting, keep your head out of the fumes
- Keep the working area well ventilated, use fume extraction or ventilation to remove welding fumes and gases.
- In confined or heavy fume environments always wear an approved air-supplied respirator. Welding fumes and gases can displace air and lower the oxygen level causing injury or death. Be sure the breathing air is safe.
- Do not weld in locations near de-greasing, cleaning, or spraying operations. The heat and rays of the arc can react with vapours to form highly toxic and irritating gases.
- Materials such as galvanized, lead, or cadmium plated steel, containing elements that can give off toxic fumes when welded. Do not weld these materials unless the area is very well ventilated, and or wearing an air supplied respirator.



## MACHINE CARE / SAFETY

Keep the welding cables, earth clamp and electrode holder in good condition. Failure to do this can result in poor welding quality, which could be dangerous in structural situations.

Prior to use, check for breakage of parts and any other conditions that may affect operation of the welder.

Any part of the welder that is damaged should be carefully checked to determine whether it will perform its intended function whilst being safe for the operator. Any part that is damaged should be properly repaired, or replaced by an authorised service centre.

### IMPROPER USE

It is hazardous to use the welding machine for any work other than that for which it was designed e.g. do not use welder for thawing pipes.

### HANDLING

Ensure the handle is correctly fitted. As welding machines can be heavy, always use safe lifting practices when lifting.

### POSITION AND HANDLING

To reduce risk of the machine being unstable / danger of overturning, position the welding machine on a horizontal surface that is able to support the machine weight. Operators **MUST NOT BE ALLOWED** to weld in raised positions unless safety platforms are used.



## SAFETY INSTRUCTIONS

### WARNING

The user of this welder is responsible for their own safety and the safety of others. It is important to read, understand and respect the contents of this user guide. When using this welder, basic safety precautions, including those in the following sections must be followed to reduce the risk of fire, electric shock and personal injury. Ensure that you have read and understood all of these instructions before using this welder.

Persons who are not familiar with this user guide should not use this welder. Keep this booklet in a safe place for future reference.

### TRAINING

The operator should be properly trained to use the welding machine safely and should be informed about the risks relating to arc welding procedures. This user guide does not attempt to cover welding technique. Training should be sought from qualified / experienced personnel on this aspect, especially for any welds requiring a high level of integrity for safety.





### SERIOUS FIRE RISK

The welding process produces sparks, droplets of fused metal, metal projectiles and fumes.

This constitutes a serious fire risk. Ensure that the area in which welding will be undertaken is clear of all inflammable materials. It is also advisable to have a fire extinguisher, and a welding blanket on hand to protect work surfaces.



## WORK AREA

-  Ensure a clear, well lit work area with unrestricted movement for the operator.
-  The work area should be well ventilated, as welding emits fumes which can be dangerous.
-  Always maintain easy access to the ON/OFF switch of the welder, and the electrical mains supply.
-  Do not expose the welder to rain and do not operate in damp or wet locations

Where welding must be undertaken in environments with increased risk of electric shock, confined spaces or in the presence of flammable or explosive materials, it is important that the environment be evaluated in advance by an “expert supervisor”. It is also recommended that welding in these circumstances be carried out in the presence of persons trained to intervene in emergencies.

### AVOID ELECTRICAL CONTACT

Use adequate electrical insulation with regard to the electrode, the work piece and any accessible earthed metal parts in the vicinity. Avoid direct contact with the welding circuit. The no load voltage between the earth clamp and the electrode can be dangerous under certain circumstances.

Note: For additional protection from electric shock. It is recommended that this welder be used in conjunction with a residual current device (RCD) with rated residual current of 30MA or less.

In general the use of extension leads should be avoided. If used however, ensure that the extension lead is used with the welder is of a suitable current rating and heavy duty in nature that **MUST** have an earth connection. If using the welder outdoors, ensure that the extension lead is suitable for outdoor use. Always keep extension leads away from the welding zone, moisture and any hot materials.

### WELDING SURFACES

Do not weld containers or pipes that hold, or have held, flammable liquids or combustible gases or pressure. Do not weld on coated, painted or varnished surfaces as the coatings may ignite, or can give off dangerous fumes.

### WORK PIECE

When welding, the work piece will remain at high temperature for a relatively long period. The operator must not touch the weld or the work piece unless wearing welding gloves. Always use pliers or tongs. Never touch the welded material with bare hands until it has completely cooled.

### VOLTAGE BETWEEN ELECTRODE HOLDERS OR TORCHES

Working with more than one welding machine on a single work piece, or on work pieces that are connected, may generate a dangerous accumulation of no-load voltage between two different electrode holders or torches, the value of which may reach double the allowed limit.





## MAINTENANCE

### WARNING

Before starting any cleaning, or maintenance procedures on the welding machine, make sure that it is switched OFF and disconnected from the mains supply.

There are no user serviceable parts inside the welder. Refer to a qualified service personnel if any internal maintenance is required. After use, wipe the welder down with a clean soft dry cloth.

Regular inspection of the supply cord is required and if damaged is suspected, it must be immediately replaced by the manufacturer, its service agent or similarly qualified persons in order to avoid a hazard

### STORAGE/ TRANSPORT

Store the welder and accessories out of children's reach in a dry place. If possible store the welder in the original packaging. The appliance must unconditionally be secured against falling or rolling over during transport.



## DISPOSAL

### DISPOSING OF THE PACKAGING

Recycling packaging reduces the need for landfill and raw materials. Reuse of the recycled material decreases pollution in the environment. Please recycle packaging where facilities exist. Check with your local council authority for recycling advice.

### DISPOSING OF THE WELDER

Welders that are no longer usable should not be disposed of with household waste but in an environmentally friendly way. Please recycle where facilities exist. Check with your local council authority for recycling advice.



## GAS BOTTLE

### ATTENTION! - CHECK FOR GAS LEAKS

At initial set up and at regular intervals we recommend to check for gas leakage

Recommended procedure is as follows:

1. Connect the regulator and gas hose assembly and tighten all connectors and clamps.
2. Slowly open the cylinder valve.
3. Set the flow rate on the regulator to approximately 10-15 l/min.
4. Close the cylinder valve and pay attention to the needle indicator of the contents pressure gauge on the regulator, if the needle drops away towards zero there is a gas leak. Sometimes a gas leak can be slow and to identify it will require leaving the gas pressure in the regulator and line for an extended time period. In this situation it is recommended to open the cylinder valve, set the flow rate to 8-10 l/min, close the cylinder valve and check after a minimum of 15 minutes. Ensuring adequate ventilation for small spaces.
5. If there is a gas loss then check all connectors and clamps for leakage by brushing or spraying with soapy water, bubbles will appear at the leakage point.
6. Tighten clamps or fittings to eliminate gas leakage.

**IMPORTANT!** - We strongly recommend that you check for gas leakage prior to operation of your machine. We recommend that you close the cylinder valve when the machine is not in use. BOSSWELD, authorised representatives or agents of BOSSWELD will not be liable or responsible for the loss of any gas.

**FRONT PANEL**

1. LCD Current Meter / Display
2. Overload error indicator
3. Multi-function Control Knob
4. Positive Output Connection Socket
5. Negative Output Connection
6. Remote Controller Plug
7. Gas Output Connector
8. AC/DC Selection Switch
9. Welding Mode Selection Button
10. 2T / 4T Selection Switch

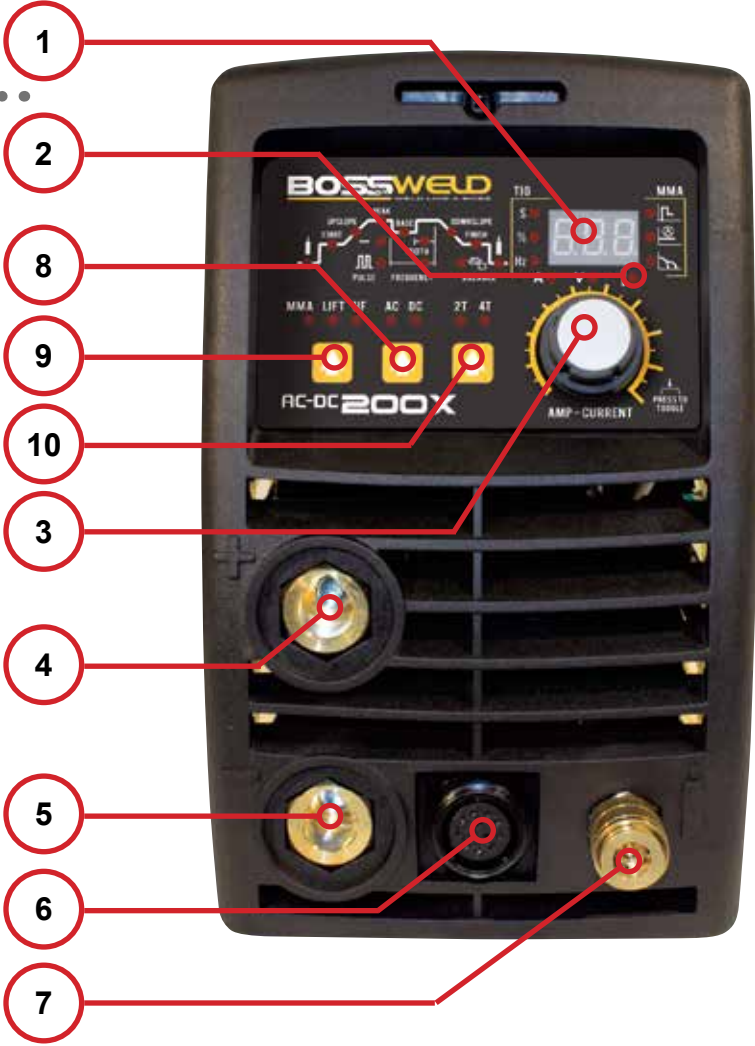

**REAR PANEL**

11. 240V AC Mains Power Switch
12. Gas Inlet Connector
13. Cooling Fan
14. 15 Amp Input Plug



**DO NOT GRIND YOUR PLUG**  
This will void any warranty  
on your machine

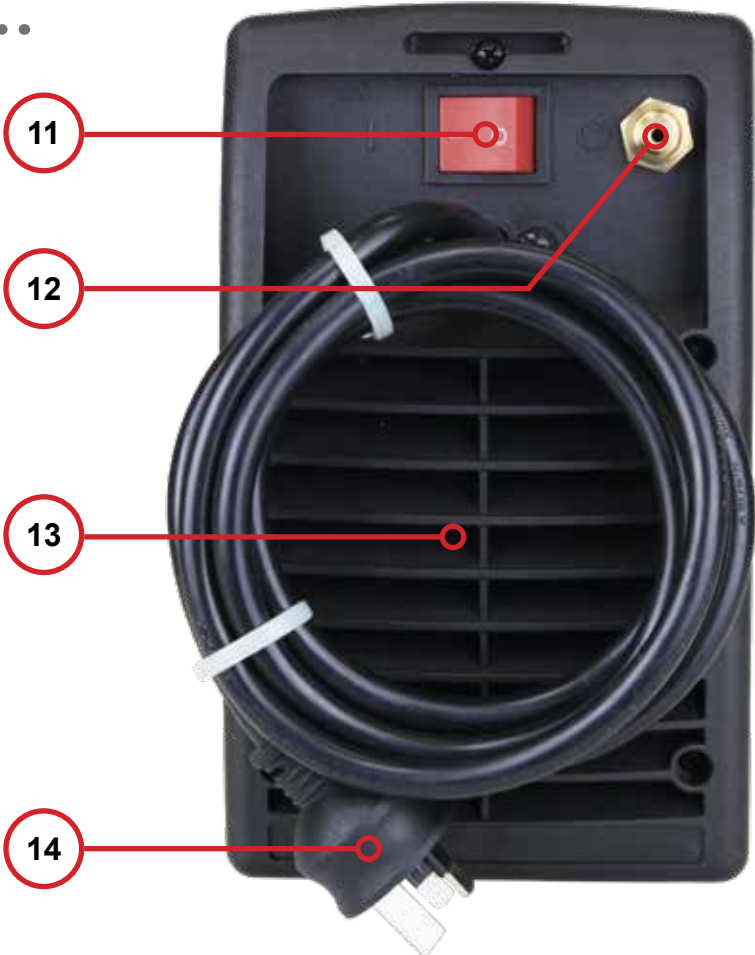

## CONTROL PANEL

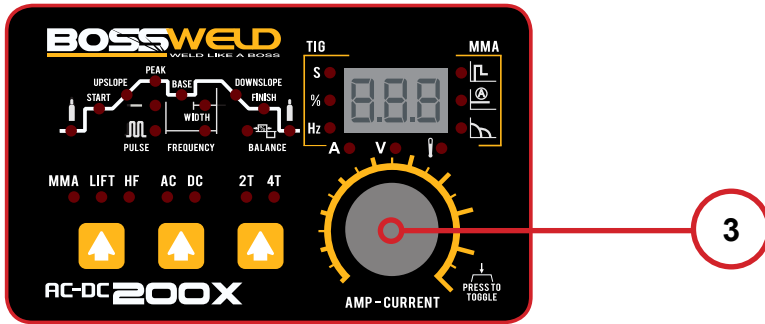

### Multi-Function Control Knob

1. Press down to toggle through the menu.
2. Turn clockwise to increase the value (or anti-clockwise to decrease the value) of the selected function.

## CONTROL DETAILS

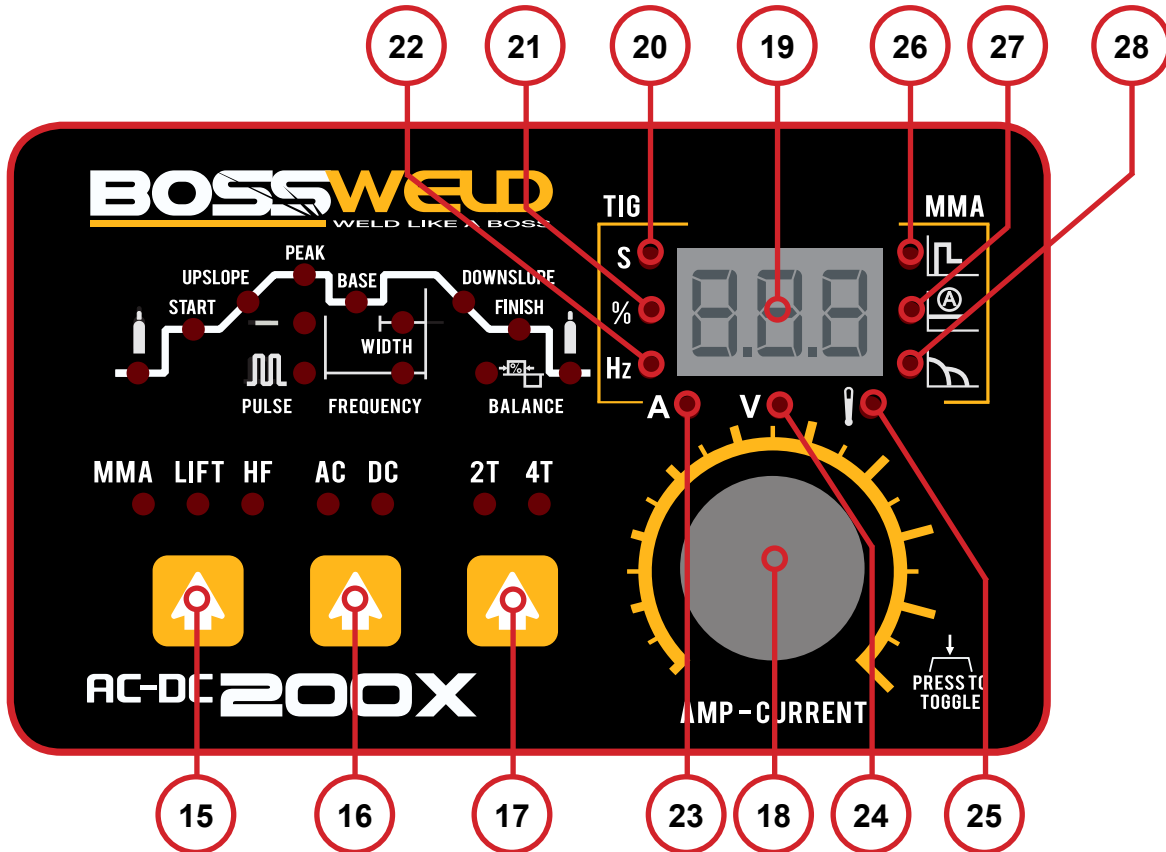

- 15 MMA / LIFT / HF Selection Switch
- 16 AC / DC Selection Switch
- 17 2T / 4T Selection Switch
- 18 Parameter Selection / Adjustment control press to change between Seconds / % / Hertz / Amps / Volts, and scroll through weld cycle. Turn to adjust selected parameter. the selected parameter will be illuminated
- 19 LCD Display panel
- 20 Illuminates when Seconds is displayed on LCD panel
- 21 Illuminates when Percentage is displayed on LCD panel
- 22 Illuminates when Hertz is displayed on LCD panel
- 23 Illuminates when Amps is displayed on LCD panel
- 24 Illuminates when Volts is displayed on LCD panel
- 25 Overload Indicator
- 26 Hot Start Indicator
- 27 Welding Current Indicator
- 28 Arc Force Indicator

## CONTROL DETAILS - CONTINUED

The labeled figure and the corresponding table explain in detail the components of the control panel. Where an indicator is lit on the control panel, the LCD panel will show the value of that indicator.

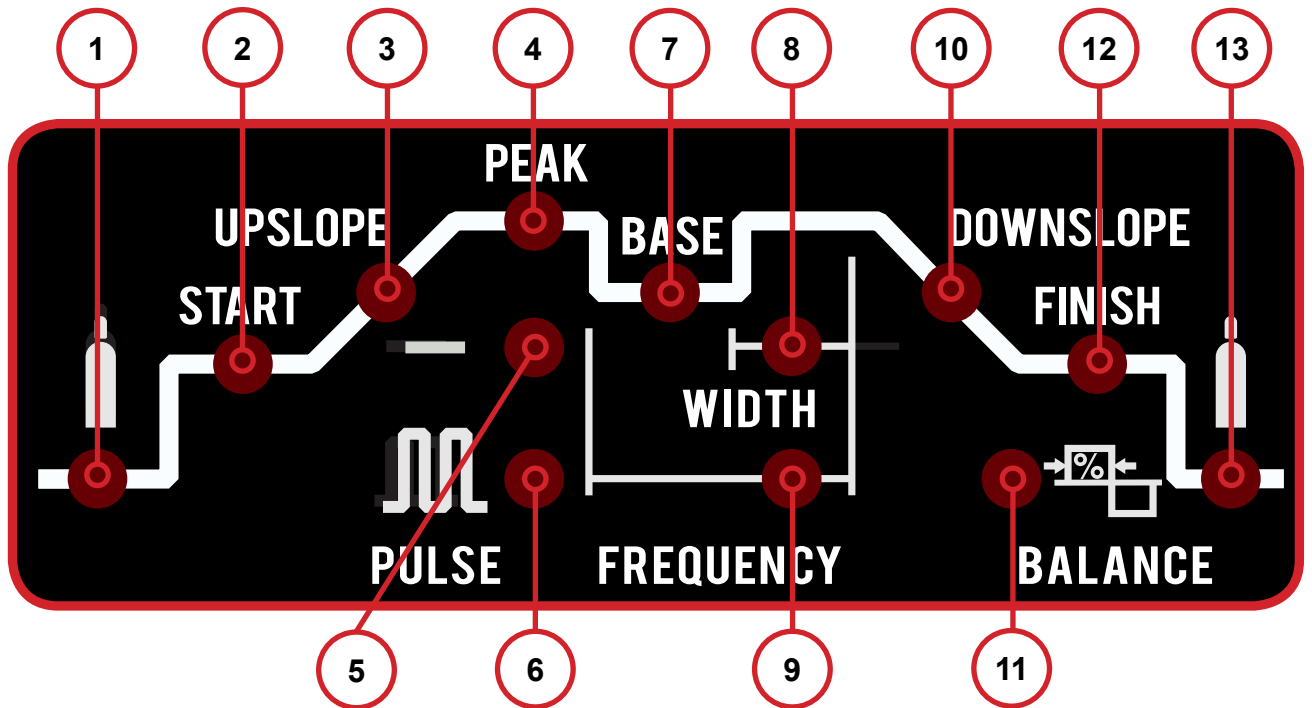

- |  |  |
|--|--|
| <p><b>1</b> <b>Gas Pre-Flow Time</b><br/>Seconds 0.0 – 2.0</p> <p><b>2</b> <b>Starting Current</b><br/>Amps DC 10 - 170<br/>AC 10 - 200</p> <p><b>3</b> <b>Upslope Time</b><br/>Seconds 1.0 – 10.0</p> <p><b>4</b> <b>Welding Peak Current</b><br/>Amps TIG DC 10 - 170<br/>TIG AC 10 - 200<br/>MMA DC 10 - 200<br/>MMA AC 10 - 200</p> <p><b>5</b> <b>No Pulse Weld</b><br/>On or off</p> <p><b>6</b> <b>Pulse Weld</b><br/>On or off</p> | <p><b>7</b> <b>Welding Base Current</b><br/>Amps TIG DC 10- 170<br/>TIG AC 10- 200<br/>MMA DC 10- 200<br/>MMA AC 10 – 200</p> <p><b>8</b> <b>Ratio of pulse Duration to Base Current Duration</b><br/>% 5-95</p> <p><b>9</b> <b>Pulse Frequency</b><br/>Hz 0.5 – 200</p> <p><b>10</b> <b>Downslope Time</b><br/>Seconds 0 - 10</p> <p><b>11</b> <b>Balance (TIG AC only)</b><br/>-5- +5</p> <p><b>12</b> <b>Crater Arc Current</b><br/>Seconds DC 10- 170<br/>AC 110 – 200</p> <p><b>13</b> <b>Gas Post Flow Time</b><br/>Seconds 0.1 – 10</p> |
|--|--|

## DUTY CYCLE

### Special note:

If this welders duty cycle is exceeded the welder will enter "thermal overload" which will automatically stop the welding output in order to protect, both the user and the welder. You will know the welder has gone into thermal overload when the overload error indicator light is illuminated. The welder will then cool itself down, and once the overload error indicator light is no longer illuminated, welding can then re-commence.

Please note. Exceeding the machine's duty cycle, cannot be considered grounds for warranty or return.

The term duty cycle indicates the percentage welding time available at the output current for each 10 min period over 4 hours,

The specification plate on the machine list three given ratings at a given current and voltage.

**NOTE: Amps refer to the Current setting - TIG DC setting duty cycle shown**

25%	60%	100%
170 - Amps	125-Amps	100-Amps
16.8 Volts	15.6 Volts	14.4 Volts

For example this means when the machine is set at a current of 170 Amps in TIG-AC it can only weld for Two an a half minutes in a Ten minute period. The power source is protected by a built in temperature protection device, This will activate if the machine is operated in excess of its amperage and duty cycle rating.



Amperage is shown on digital display

The Overload Error Indicator light indicates

- Over temperature
- Duty cycle exceeded

AC TIG Duty Cycle

BOSSWELD		INVERTER AC DC TIG WELDER		PART NO.	692200
BOSSWELD 200X AC/DC				STANDARD	IEC 60974
AC TIG	10A/10.4V-200A/18V	X	25%	60%	100%
	I <sub>2</sub> 200A 125A 100A				
AC MMA	10A/10.4V-170A/16.8V	X	25%	60%	100%
	I <sub>2</sub> 170A 125A 100A				
DC TIG	10A/20.4V-170A/26.8V	X	15%	60%	100%
	I <sub>2</sub> 170A 115A 80A				
DC MMA	10A/20.4V-170A/26.8V	X	15%	60%	100%
	I <sub>2</sub> 170A 115A 80A				
U <sub>0</sub> =52V U <sub>1</sub> =240V I <sub>1max</sub> =30.5A I <sub>1ref</sub> =15A		U <sub>0</sub> =52V U <sub>1</sub> =240V I <sub>1max</sub> =28.3A I <sub>1ref</sub> =14A			
U <sub>2</sub> 18V 16.2V 14.8V		U <sub>2</sub> 16.8V 15.6V 14.4V			
U <sub>2</sub> 26.8V 25.6V 24.4V		U <sub>2</sub> 26.8V 25.6V 24.4V			
U <sub>0</sub> =52V U <sub>1</sub> =240V I <sub>1max</sub> =39.1A I <sub>1ref</sub> =15A		U <sub>0</sub> =52V U <sub>1</sub> =240V I <sub>1max</sub> =39.7A I <sub>1ref</sub> =15A			
1-50-60Hz		IP21	H	AF	7Kg

Duty Cycle

Amperage / Current

Voltage

DC Duty Cycle  
TIG / MMA

AC MMA Duty Cycle

## AC / DC WELDING

Alternating current (AC) is electricity that switches direction back and forth so the voltage also periodically reverses because the current changes direction. Typical AC currents are what you would expect to see from your electrical outlets in your home and often used in higher voltage devices such as household appliances. AC current changes its polarity 120 times per second with a 60-hertz current. Reversed polarity (AC) results in deeper penetration.

In Alternate Current (AC) welding, since the current and the magnetic field of the arc reverse direction many times a second, there is no net deflection of the arc.

### Applications of AC Welding

AC welding can be used to weld magnetic metals. This cannot be done with DC welding. AC welding is ideal for the following types of welds:

- Downhand heavy plate
- Fast fill
- Aluminum TIG welding with high frequency

The primary advantage of using AC welding is that it allows the weld operator to weld on magnetized materials. In AC current, the current changes direction and is not affected by magnetism. The arc remains stable and is easier to control.

### AC welding is also the preferred method for:

- TIG welding aluminum, because the current supports welding at a higher temperature.
- Making repairs on machinery because the machinery usually has a magnetized field and is older and may have rusty areas where there is concern about the higher heat penetration that can occur with DC welding.
- Seam welding in shipbuilding because the current settings can often be higher than those used in DC welding and a deeper penetration of plate metals can be obtained.

The biggest drawback to using AC welding is the quality of the weld. It is not as smooth as DC welding because of the continuous change in directional flow and there is likely to be more spatter.

### Applications of DC Welding

Welding with DC is best used for:

- Hard facing
- Overhead or vertical welding
- Single carbon brazing
- Build-up of heavy deposits
- Stainless steel TIG welding
- Cutting tap

### As a rule of thumb, DC is preferred for welding because:

It produces a smoother weld and there is less spatter because of the constant linear direction of the current. It maintains a constant and stable arc and is thus easier to handle and more reliable than AC current.

Machinery that uses DC current is generally cheaper and easier to use.

It welds thinner metals better than AC current.

### Overall Strength of Welds

Overall the strength of the weld can be determined by many factors, such as:

- Proper electrode, welding apparatus and procedures;
- Properties of the materials being welded-magnetic vs. non-magnetic;
- Proper edge preparation-the cleaner the edge, the better the weld;
- Current settings – DC vs. AC;
- Speed of travel – the angle of the electrode needs to be maintained throughout the length of the joint as it is being welded.

A strong weld can be achieved in both AC welding and DC welding so long as you weld with the current and polarity appropriate for the material being welded. One doesn't necessarily, always and everywhere, produce a better weld than the other. It's a matter of choosing the right one for your job.

## PULSE TIG WELDING

TIG welding with the pulse feature is most often done for thin metals such as aluminum and can also be used with copper and varieties of steel. Pulsing can be set up with a foot pedal or as a setting on your TIG welder, but when should you use pulsing? There are some very specific applications for pulsing with a TIG welder and then there are times when it can just come in handy to get a job done better. Here's a look at some TIG welding with pulse applications:

### Greater Control Over the Heat

Pulse for TIG is all about improving your control when you don't want to burn through your metal work piece. Using the pedal or setting up the pulse will moderate the heat as you weld and ensure you have enough heat present at the joint without laying a ton of filler metal into the joint or burning through the metal.

Too much metal in the weld joint could create a headache for your welding project, as you'll have to stop to grind it down and then clean up the metal before you can start welding again. The pulse setting gives you far more control over the welding process without compromising the strength and integrity of your weld.

### When You Need a Neat Weld

Pulsing your weld is an easy way to create a smooth, clean weld for a TIG welding application.

Getting yourself in a steady pulsing rhythm is an ideal way to keep moving the puddle forward or walking the cup along a weld joint.

TIG welding is most often used when there is little margin for error and the metal is especially thin.

By pulsing along the weld joint you can moderate the amount of filler metal you add so that it's evenly distributed and you create a great looking weld.

### Minimal Movement

If you're in a tight spot and you don't have a lot of room to maneuver, pulsing your TIG welder is one way to glide along the weld joint, adding filler metal as you go, without worrying about introducing too much heat and filler. The main thing for this application will be a steady hand on the torch and an even pace for the filler metal. If this is a particularly tight spot, you can pick up shorter torches that have a very small head and can fit in a variety of spaces. With TIG welding you can reach a tight spot much better than with a stick welder and you can control the input of filler metal better than with MIG, making it a great option when welding is particularly challenging.

### Moving Faster with High Speed Pulse

Given some practice, many welders can effectively weld at the high speed of 150 pulses per second, creating neat welds in far less time. While you wouldn't want to try a faster pulsing speed if you're not used to it, many welders prefer to move either really slow or really fast in order to create a steady rhythm. Pulsing at around 20 per second has led some welders to make uneven, spotty welds.

This would be especially useful in a fabrication shop where you're seeing a lot of the same metal work pieces over and over and over again. If you have a handle on how fast you need to move on each piece, then there's a good chance you can bump up the pulsing rate to improve your welding speed.

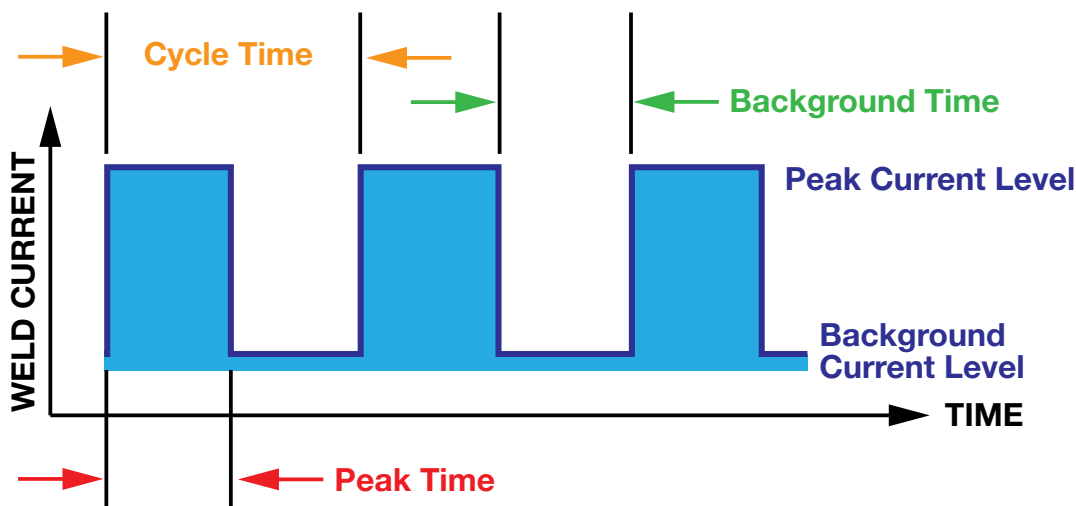

## 2T / 4T TRIGGER CONTROL

### 2T Trigger Control

1. Press the trigger and Hold
2. The set pre-gas flow starts and the arc starts and will upslope to the amperage selected on the amperage dial.
3. When you want to finish the weld, release the trigger and the amperage will begin to downslope at the rate you have selected on the downslope dial, If you selected zero the arc will stop as soon as you release the trigger.

### 4T Trigger Control

1. Press the trigger and Hold
2. The set preflow gas starts and the arc starts.
3. Release the trigger and the amperage will upslope to the amperage selected on the amperage dial
4. When you want to finish the weld, press and hold the trigger and the amperage will begin to downslope at the rate you have selected on the downslope dial, amperage will remain at this level until you release the trigger.
5. Once you have released the trigger the arc will stop and the postflow gas will continue for a pre set amount of time

## LIFT ARC START

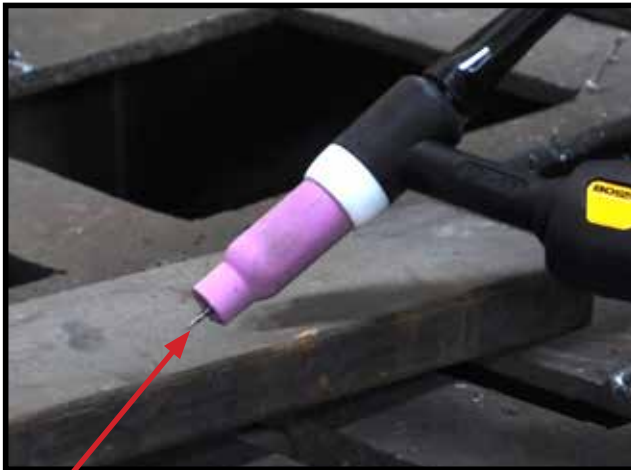

- 1** Lay the outside edge of the Gas Cup on the work piece with the Tungsten Electrode 1- 2mm from the work piece.

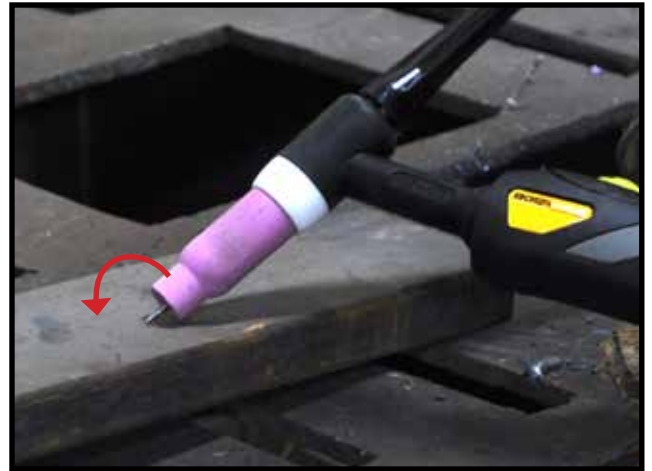

- 3** With a small movement rotate the Gas Cup forward so that the Tungsten Electrode touches the work piece.



- 2** Press the button on the TIG torch



- 4** Now rotate the Gas Cup in the reverse direction to lift the Tungsten electrode from the work piece to create the arc.



## HF ARC START

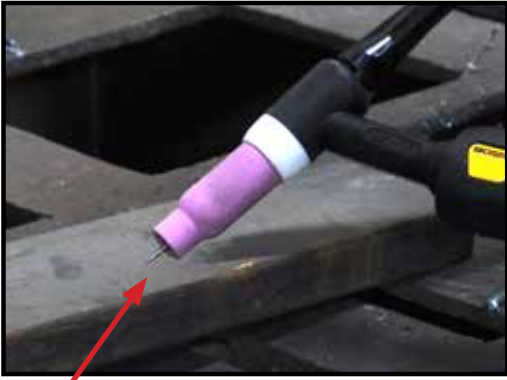

**1** Lay the outside edge of the Gas Cup on the work piece with the Tungsten Electrode 1- 2mm from the work piece.



**2** Press the button on the TIG torch



**3** The Arc will start forming an arc between the tungsten tip and the work piece

## FOOT CONTROL - OPTIONS

**Bossweld Foot Control 3mt**  
Part No: 660201



3 metre cord Ideal for bench work Parent-Child relationship between the welder and foot controller. This means if you set the welder to 120 Amps, the foot controller range will be between min and 120 Amps.

## MACHINE SET UP STICK/MMA

**Note: The below image shows setup for DCEP / Negative Polarity**  
(Most Common application)

6. Select Stick / MMA mode

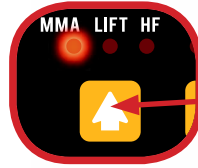

2. Connect Electrode holder to the **+** terminal

3. Connect earth Clamp to the **-** terminal



**1** Plug the machine 15Amp input power lead into the wall socket, ensuring that the power switch on the machine is in the OFF position.

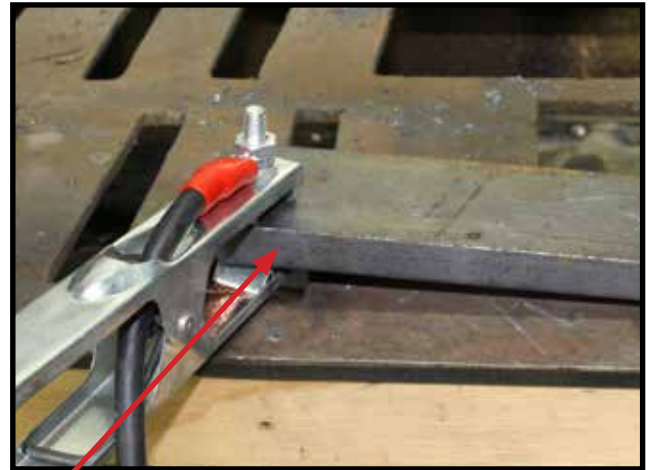

**3** Connect earth clamp firmly to work-piece ensuring that the clamp makes good contact with bare metal.



**2** Assemble Arc and Earth leads into the welding terminals depending on requirements of electrodes. Refer to your electrode packet for polarity and current requirements.

- DCEP/ Negative Polarity (most common application)
  - Earth clamp connector into the negative terminal.
  - Electrode holder connector into the positive terminal.
- DCEN/Straight Polarity
  - Earth clamp connector into the Positive terminal.
  - Electrode holder connector into the Negative terminal.

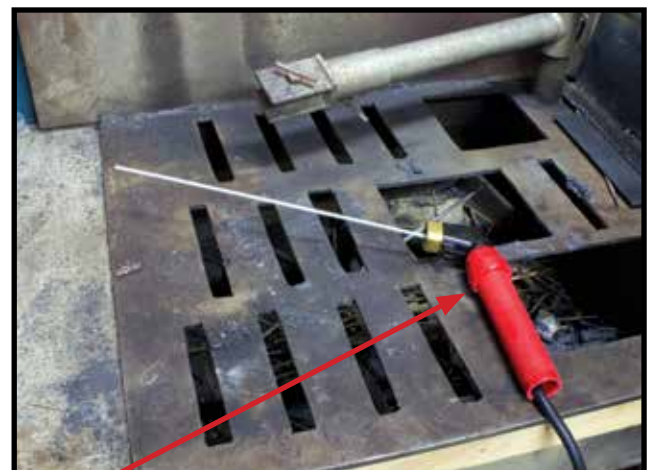

**4** Take electrode holder and twist the handle to open the lock. Insert bare metal rod end of electrode and twist the handle to clamp electrode.

# MACHINE SET UP STICK/MMA - CONTINUED

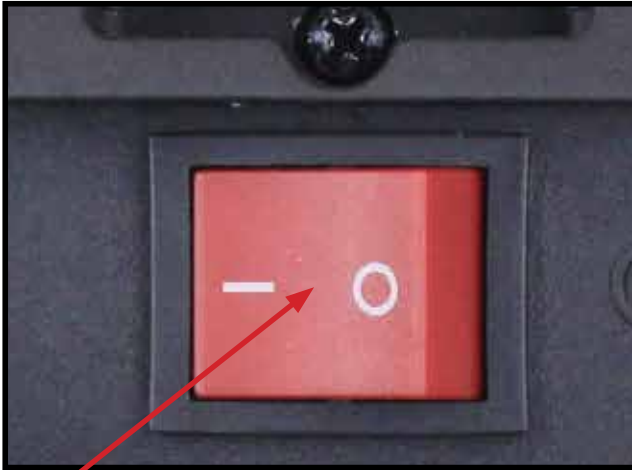

**5** Ensure the electrode/electrode holder is not near the work-piece or can earth out, turn the machine on using the mains power switch. The front displays will light up and the cooling fan will start.

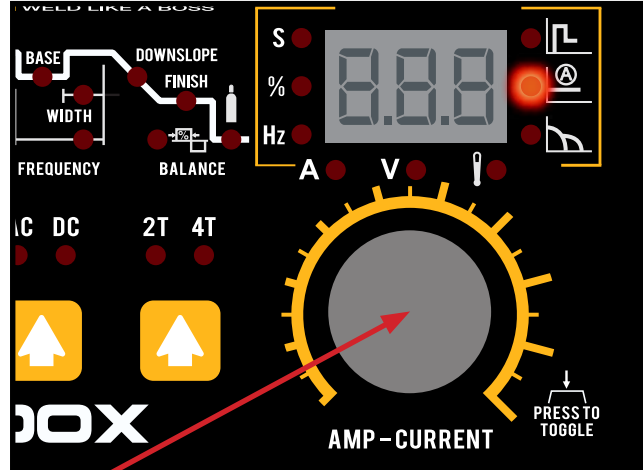

**8** Select your required amperage by turning the Multi-Function Control knob

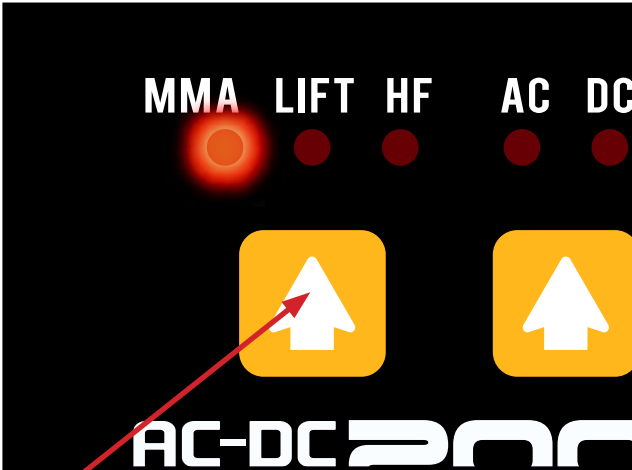

**6** Select Stick / MMA on Welding Output Mode Switch.

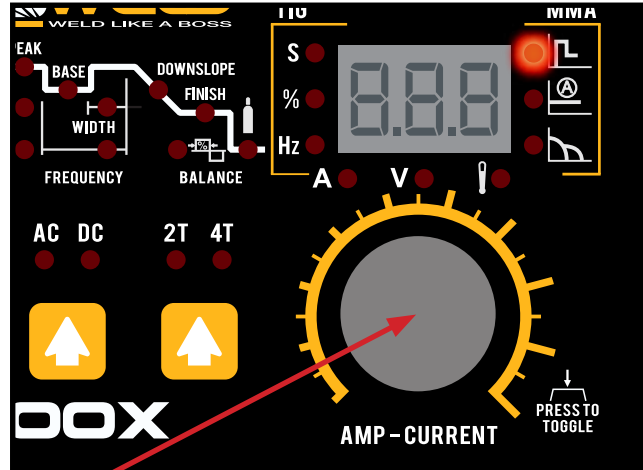

**9** You can adjust the Hot Start by pressing the Multi-Function Control knob to cycle to Hot start then adjusting to the required parameter

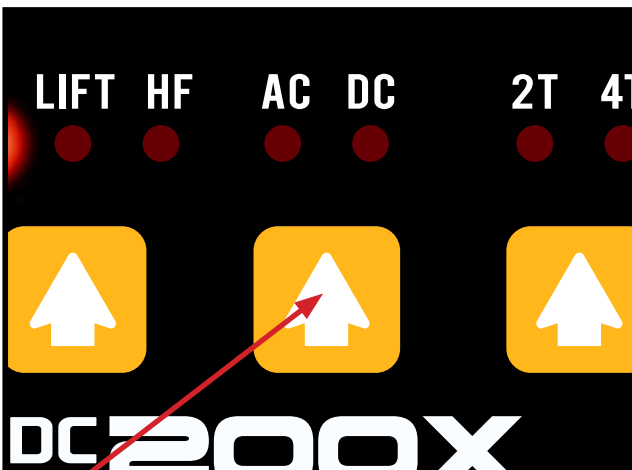

**7** Select the desired welding wave form (AC or DC) using the AC/DC Selection switch (DC is the most common electrode type)

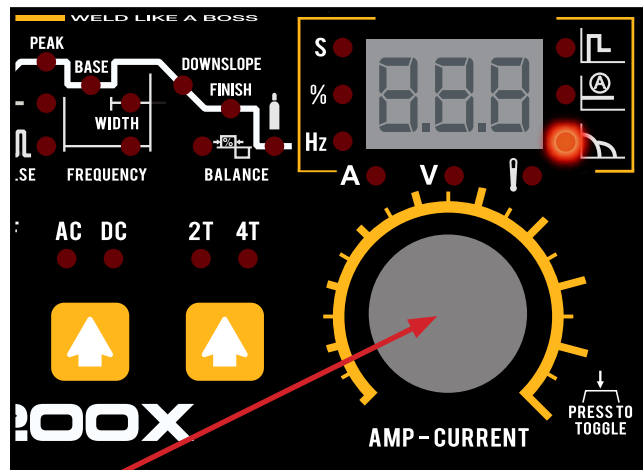

**10** You can adjust the Arc force by pressing the Multi-Function Control knob to cycle to Arc Force then adjusting to the required parameter.

## ELECTRODE SIZE SELECTION

Electrode size selection will be determined by the thickness of the section being welded. A thicker section will need a larger diameter electrode. The table below shows the maximum size of electrodes for average thicknesses of section (based on General Purpose 6013 Electrode).

Average Metal Thickness	Electrode Size
1.0 - 2.0mm	2.0mm
2.0 - 5.0mm	2.6mm
5.0 - 8mm	3.2mm
8.0mm +	4.0mm

## WELDING CURRENT

Welding current level is determined by the size of electrode - the normal operating range and current are recommended by manufacturers. Typical operating ranges for a selection of electrode sizes are illustrated in the table. As a rule of thumb when selecting a suitable current level, an electrode will require about 40 Amps per millimetre (diameter). Therefore, the preferred current level for a 4mm diameter electrode would be 160 Amps, but the acceptable operating range is 140 to 180 Amps. It is important to match the machine to the job

Amperage Selection Guide	
Rod Size/ Gauge	Welding Current
1.6mm	40-50 Amps
2.0mm	50-75 Amps
2.5mm	75-105 Amps
3.2mm	105-140 Amps
4.0mm	140-160 Amps

## MANUAL METAL ARC PROCESS (MMA WELDING)

When an arc is struck between the metal rod (electrode) and the workpiece, both the rod and workpiece surface melt to form a weld pool. Simultaneous melting of the flux coating on the rod will form gas and slag which protects the weld pool from the surrounding atmosphere. The slag will solidify and cool and must be chipped off the weld bead once the weld run is complete (or before the next weld pass is deposited). The process allows only short lengths of weld to be produced before a new electrode needs to be inserted in the holder. Weld penetration is low and the quality of the weld deposit is highly dependent on the skill of the welder.

### TYPES OF ELECTRODES

Arc stability, depth of penetration, metal deposition rate and positional capability are greatly influenced by the chemical composition of the flux coating on the electrode. There are many types of Electrodes, and these are generally matched to the base metal. For example if welding Mild Steel then select a Mild Steel (General Purpose Electrode). Electrodes are identified by a universal numbering system (AWS Type code).

Base Metal	Electrode Type	Type
Mild Steel	Mild Steel General Purpose	6013
Stainless Steel	Stainless Steel 316L	316L
Dissimilar Metals	Dissimilar 680	312
Cast Iron	Nickel Arc 98	Ni99
High Strength Steel	Low Hydrogen	TC16

Electrodes are often packed in sealed packaging to keep moisture out. However, if a pack has been opened or damaged, it is essential that the electrodes are redried according to the manufacturer's instructions.

### ARC FORCE

Also called Dig and Arc Control. Gives a power source variable additional amperage during low voltage (short arc length) conditions while welding. Helps avoid "sticking" stick electrodes when a short arc length is used.

### POWER SOURCE

Electrodes can be operated with AC and DC power supplies. Not all DC electrodes can be operated on AC power sources; however AC electrodes may be used on either AC or DC

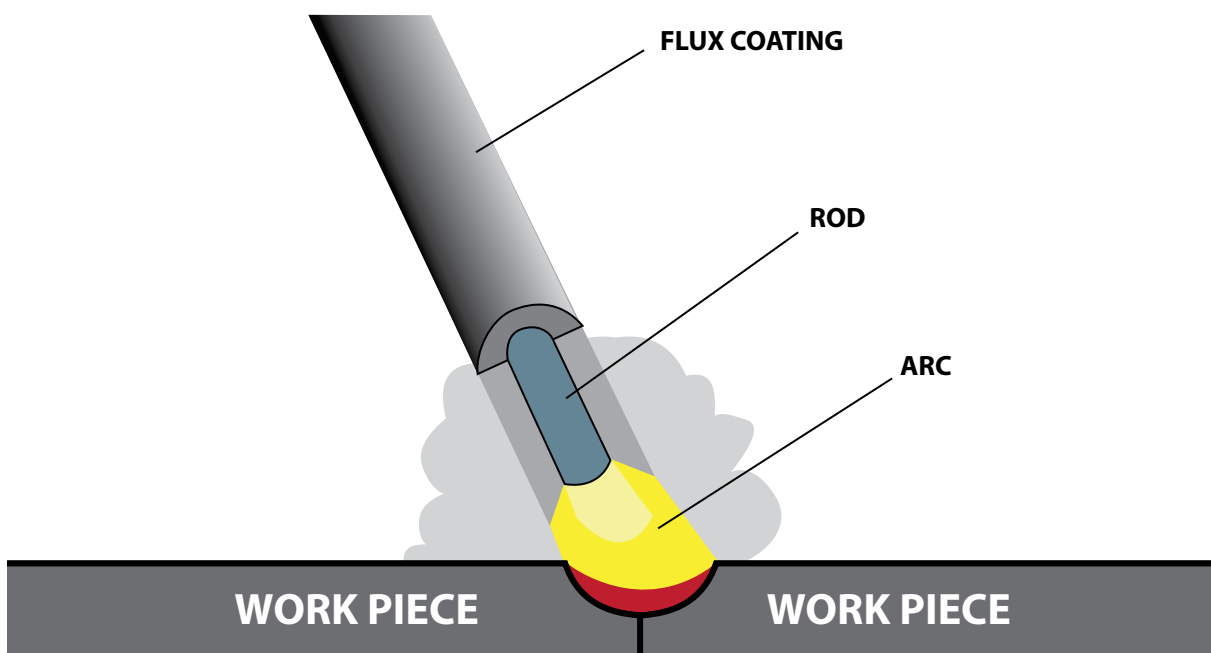

## MACHINE SET UP TIG WELD

4. Connect the Argon Gas Regulator supplied to the Gas bottle and connect the Gas Hose to the Gas Input socket on the rear of machine and the Regulator. Ensure the Gas regulator is in the off position.

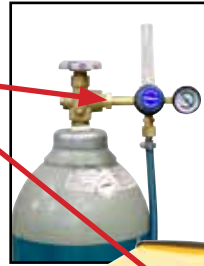

2. Connect the Gas hose to the Gas Output and the TIG Torch Control Socket and screw the nut up firmly.

8. Select TIG LIFT OR HF Start mode

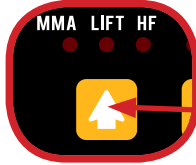

5. Connect earth Clamp to the **+** terminal

2. Connect TIG Torch to the **-** terminal



1. Plug the machine 15Amp input power plug into the wall socket, ensuring that the power switch on the machine is in the OFF position.

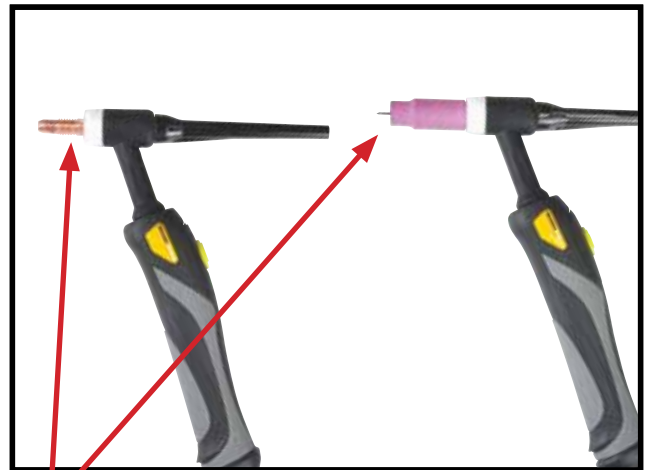

3. Set up the TIG torch. Place the Tungsten Electrode into the torch head and ensure back cap and collet body are screwed in firmly.



2. Install the TIG Torch to the machine by connecting the Dinse Connector to the Negative Output Connection Socket, the Gas hose to the Gas Output and the TIG Torch Control Socket and screw the nut up firmly.

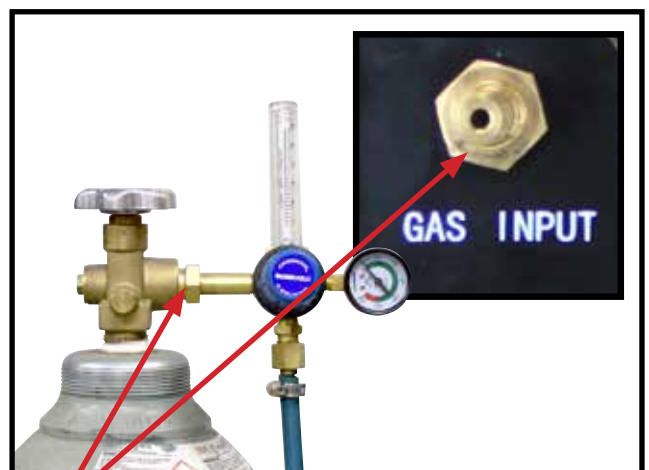

4. Connect the Argon Gas Regulator supplied to the Gas bottle and connect the Gas Hose to the Gas Input socket on the rear of machine and the Regulator. Ensure the Gas regulator is in the off position.

## MACHINE SET UP TIG WELD

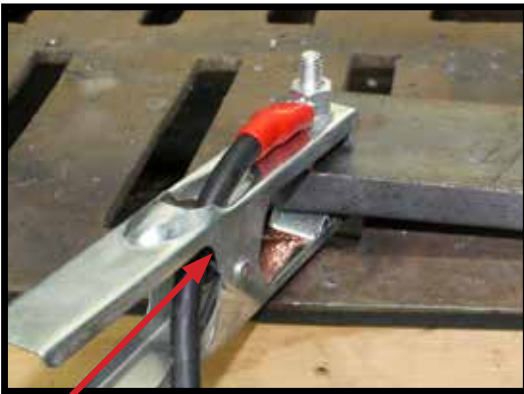

**5** Fit the Earth lead Dinse Plug to the positive terminal and then connect earth clamp to the work piece ensuring that the clamp makes good contact with bare metal.



**6** Switch the machine on using the mains power switch. Wait a few seconds whilst the machine powers up

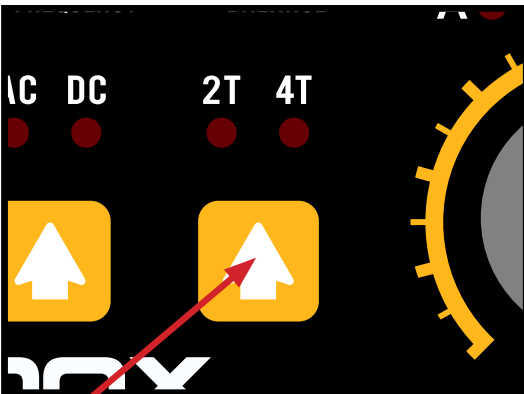

**7** Set the Trigger Mode to 2T or 4T using the 2T / 4T Selection Switch as desired

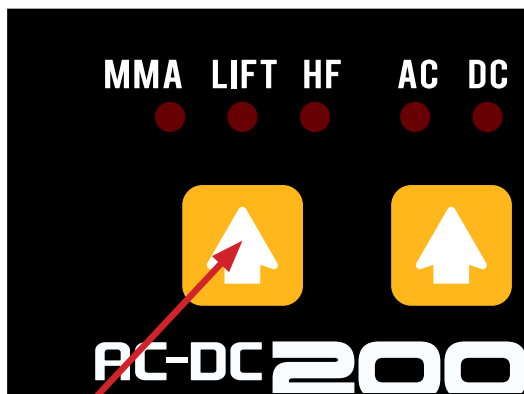

**8** Select desired Arc ignition Lift or HF using the Welding Mode Selection button

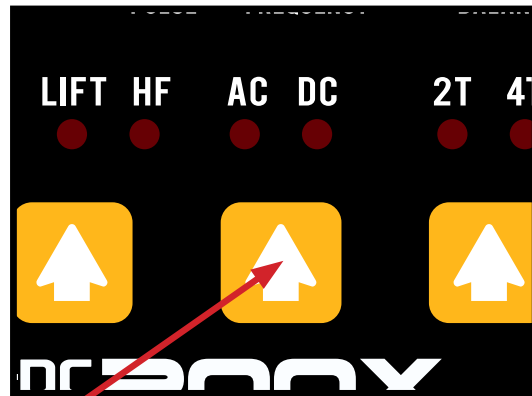

**9** Select AC or DC welding AC/DC Selection Switch

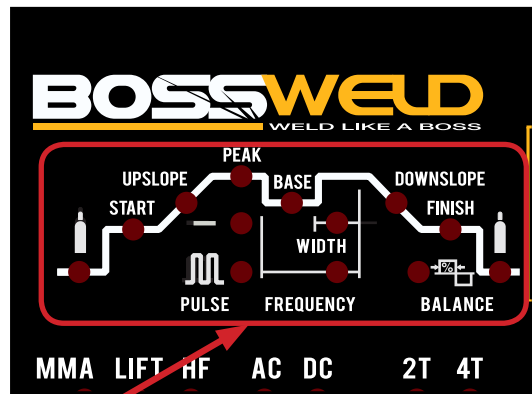

**10** Set remaining parameters referring to the table on page 24 to 26. Please note not all parameters are relevant to DC TIG welding.

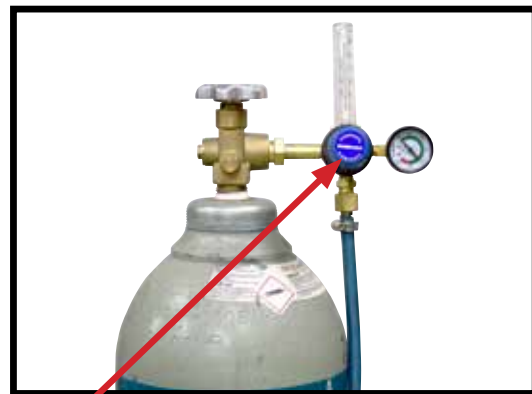

**11** Turn on regulator and set gas flow to between 10-15 L/min depending on your welding environment.

**Note:** It is advisable to run a few test welds using scrap or offcut materials, in order to tune the machine to the correct settings prior to welding the job.

### IMPORTANT! -

We strongly recommend that you check for gas leakage prior to operation of your machine. We recommend that you close the cylinder valve when the machine is not in use. BOSSWELD authorised representatives or agents of BOSSWELD will not be liable or responsible for the loss of any gas.

**Note:** Pictures may vary from your machine model

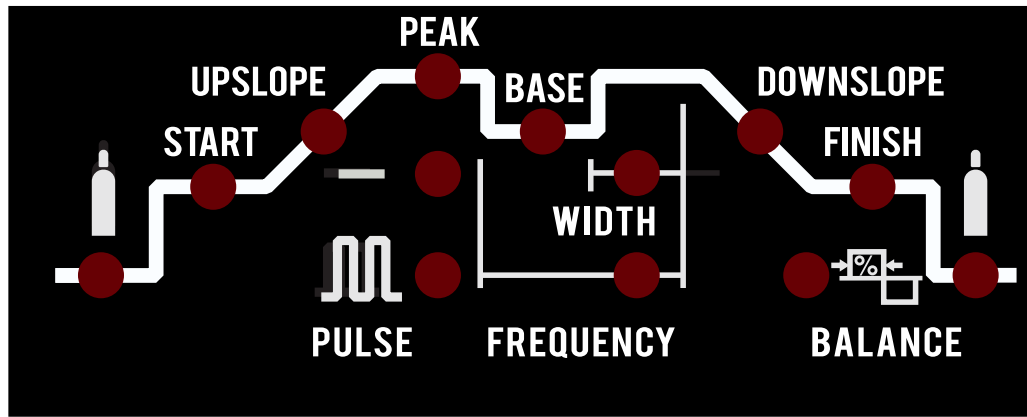

## BASIC WELD CYCLE EXPLANATION

### Pre Gas

Selection for gas flow time prior to the arc starting.

### Start Current

Selection for the amount of amps required at the start of the weld.

### UpSlope

Selection for the transition time from Start Amperage to Peak Amperage.

### Peak Current

Selection for the Maximum Welding Amperage required during welding.

### Pulse

Selection for Pulse or No Pulse.

### Base Current only when Pulse is Selected

Selection for the Base Welding Amperage required during welding.

### DownSlope

Selection for the transition time from Peak Amperage to Finish Amperage.

### Crater Arc Current

Selection for the amount of fill at the end of the weld

### Post Gas

Selection for gas flow time after the arc finishes.

## AC WELDING ONLY

### Balance

Selection to adjust the balance of the AC wave form in AC TIG mode. Adjustment of the arc to be balanced, penetrating or oxide cleaning during AC TIG welding



# AC/DC TIG WELD CYCLE SETUP

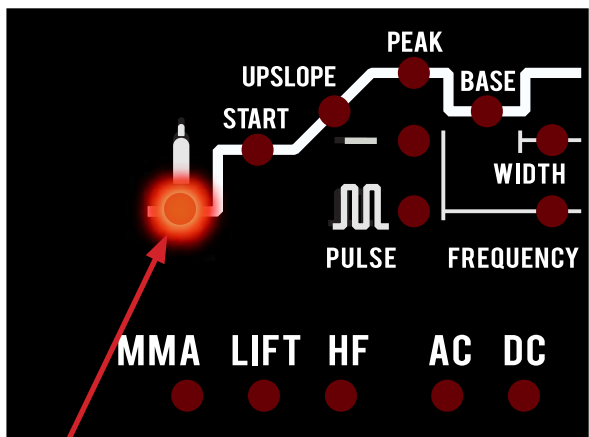

**1** Pressing the Multi-Function Control knob to cycle to Pre Gas then adjusting to the required parameter  
**0.0 - 2.0 Seconds**

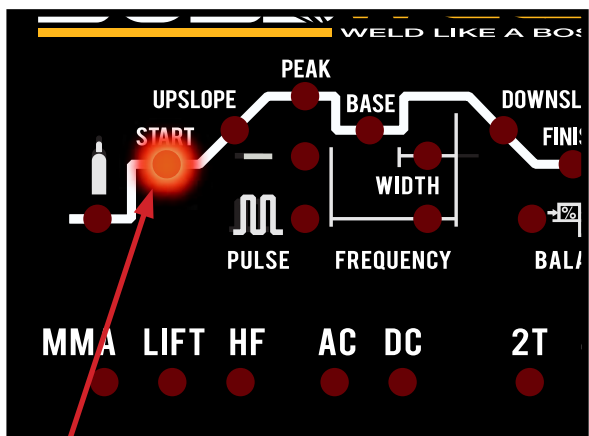

**2** Pressing the Multi-Function Control knob to cycle to Start Current then adjusting to the required parameter  
**Amps DC 10 - 170**  
**AC 10 - 200**

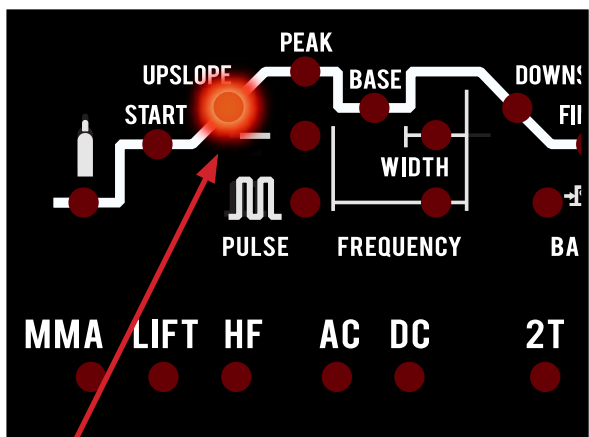

**3** Pressing the Multi-Function Control knob to cycle to Upslope then adjusting to the required parameter  
**1.0 - 10.0 Seconds**

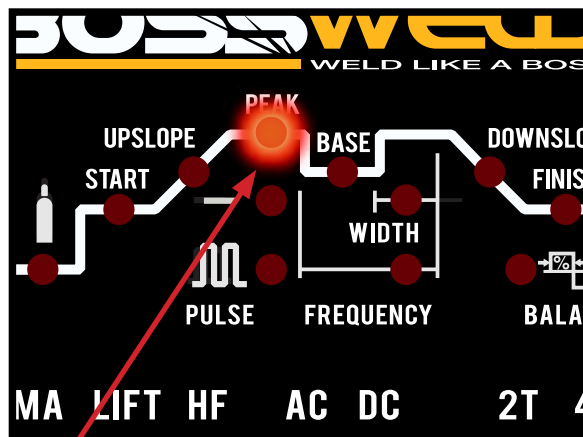

**4** Pressing the Multi-Function Control knob to cycle to Peak Current then adjusting to the required parameter  
**Amps TIG DC 10 - 170**  
**TIG AC 10 - 200**  
**MMA DC 10 - 200**  
**MMA AC 10 - 200**

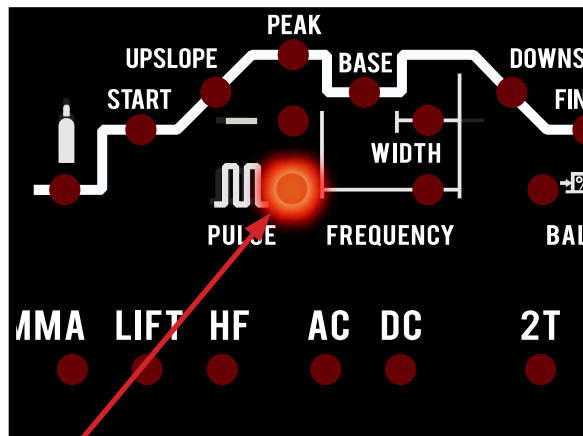

**5** Pressing the Multi-Function Control knob to cycle to Pulse Function, you can either select No Pulse or Pulse the digital screen will display like below

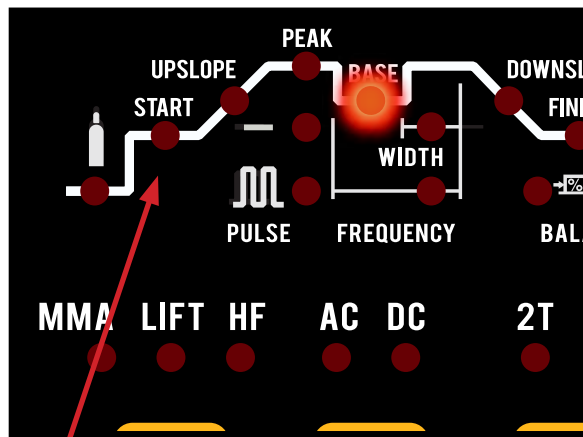

**6** IF PULSE IS SELECTED Pressing the Multi-Function Control knob to cycle to Base Current then adjusting to the required parameter  
**Amps TIG DC 10 - 170**  
**TIG AC 10 - 200**  
**MMA DC 10 - 200**  
**MMA AC 10 - 200**

## AC/DC TIG WELD CYCLE SETUP

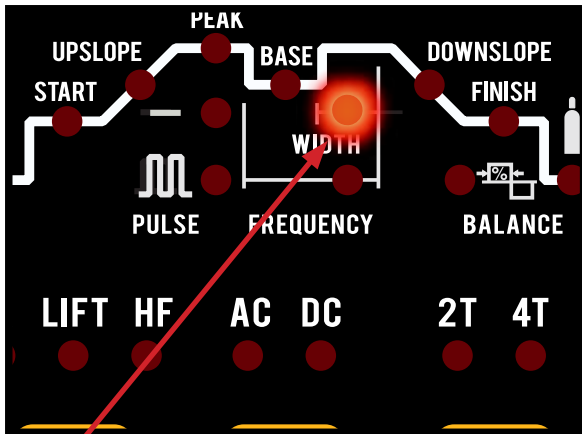

**7** Pressing the Multi-Function Control knob to cycle to Width or duration of base current then adjusting to the required parameter

% 5-95

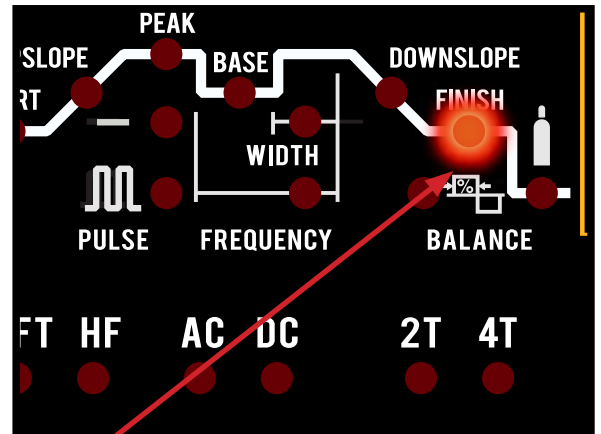

**10** Pressing the Multi-Function Control knob to cycle to Crater Arc Current then adjusting to the required parameter

Seconds DC 10- 170  
AC 110 – 200

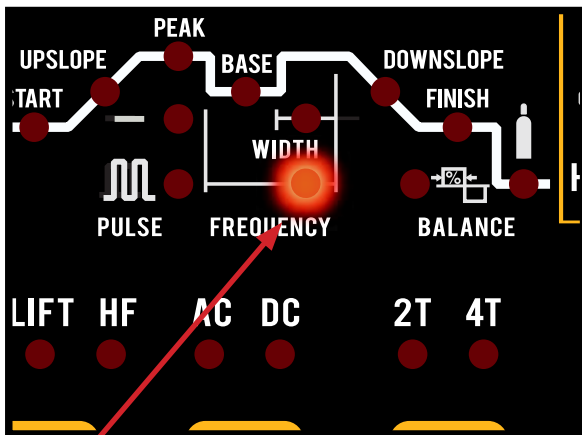

**8** Pressing the Multi-Function Control knob to cycle to Frequency, then adjusting to the required parameter

Hz 0.5 – 200

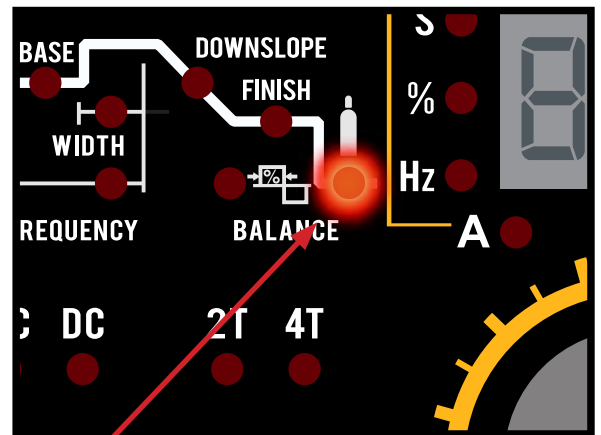

**11** Pressing the Multi-Function Control knob to cycle to Post gas then adjusting to the required parameter

1.0 - 10.0 Seconds

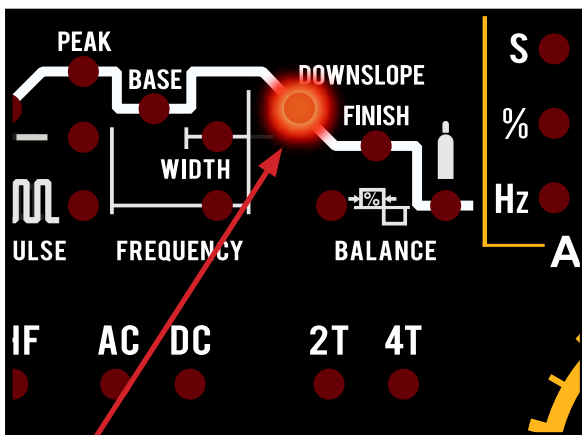

**9** Pressing the Multi-Function Control knob to cycle to Downslope then adjusting to the required parameter

1.0 - 10.0 Seconds

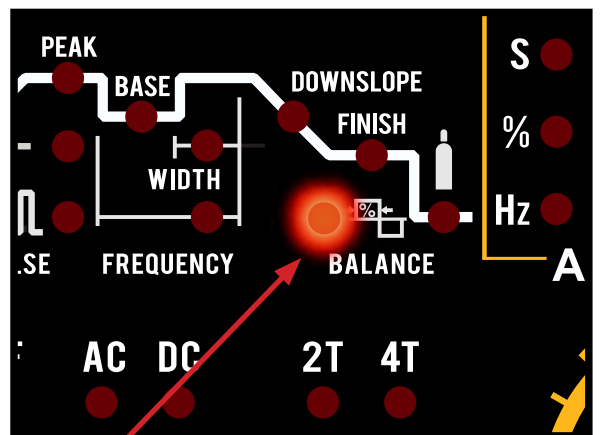

**12** NOTE THIS STEP IS ONLY VALID IN AC WELDING

Pressing the Multi-Function Control knob to cycle to Balance then adjusting to the required parameter

-5- +5 %

## TUNGSTEN SELECTION / PREPARATION & GRINDING

### ELECTRODES

Electrodes for DC welding are normally pure tungsten with 1 to 4% thoria to improve arc ignition. Alternative additives are lanthanum oxide and cerium oxide which are claimed to give superior performance (arc starting and lower electrode consumption). It is important to select the correct electrode diameter and tip angle for the level of welding current. As a rule, the lower the current the smaller the electrode diameter and tip angle. In AC welding, as the electrode will be operating at a much higher temperature, tungsten with a zirconia addition is used to reduce electrode erosion. It should be noted that because of the large amount of heat generated at the electrode, it is difficult to maintain a pointed tip and the end of the electrode assumes a spherical or 'ball' profile.

Grinding creates the greatest hazard as the exposed tungsten/thoria area is greatly increased and fine particles of potentially radioactive dust are released into the atmosphere. It is recommended that a dedicated grindstone with local dust extraction is used, and a simple filter mask is worn. If the grinding wheel is not fitted with a protective viewing screen, eye protection must be worn.

#### CORRECT PREPERATION - STABLE ARC

#### INCORRECT PREPERATION - STABLE ARC

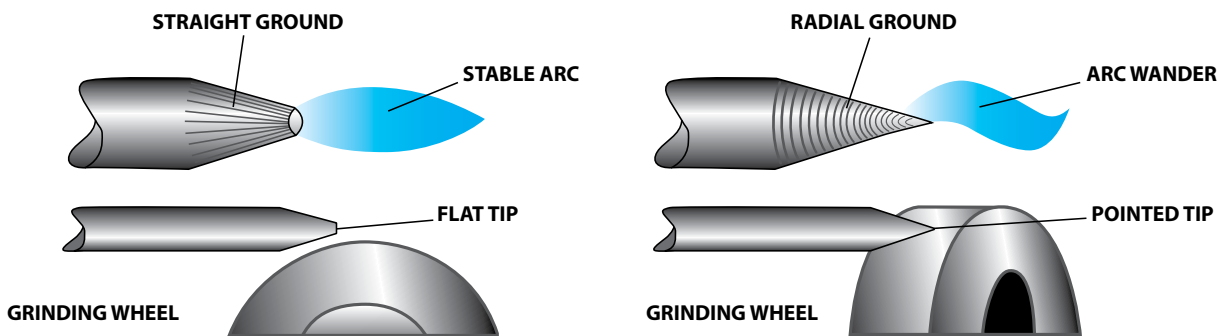

**Note:** Do not use wheel for other jobs or tungsten can become contaminated and cause lower weld quality

### TIG WELDING

Tungsten inert gas (TIG) welding became an overnight success in the 1940s for joining magnesium and aluminium. Using an inert gas shield instead of a slag to protect the weldpool, the process was a highly attractive replacement for gas and manual metal arc welding. TIG has played a major role in the acceptance of aluminium for high quality welding and structural applications.

#### PROCESS CHARACTERISTICS

In the TIG process the arc is formed between a pointed tungsten electrode and the workpiece in an inert atmosphere of argon or helium. The small intense arc provided by the pointed electrode is ideal for high quality and precision welding. Because the electrode is not consumed during welding, the welder does not have to balance the heat input from the arc as the metal is deposited from the melting electrode. When filler metal is required, it must be added separately to the weldpool.

#### POWER SOURCE

TIG must be operated with a constant current power source - either DC or AC. A constant current power source is essential to avoid excessively high currents being drawn when the electrode is short-circuited onto the workpiece surface. This could happen either deliberately during arc starting or inadvertently during welding. If, as in MIG welding, a flat characteristic power source is used, any contact with the workpiece surface would damage the electrode tip or fuse the electrode to the workpiece surface. In DC, because arc heat is distributed approximately one-third at the cathode (negative) and two-thirds at the anode (positive), the electrode is always negative polarity to prevent overheating and melting. However, the alternative power source connection of DC electrode positive polarity has the advantage in that when the cathode is on the workpiece, the surface is cleaned of oxide contamination. For this reason, AC is used when welding materials with a tenacious surface oxide film, such as aluminium.

#### ARC STARTING

The welding arc can be started by scratching the surface, forming a short-circuit. It is only when the short-circuit is broken that the main welding current will flow. However, there is a risk that the electrode may stick to the surface and cause a tungsten inclusion in the weld.

## TIG WELDING - CONTINUED

This risk can be minimised using the 'lift arc' technique where the short-circuit is formed at a very low current level. The most common way of starting the TIG arc is to use HF (High Frequency). HF consists of high voltage sparks of several thousand volts which last for a few microseconds. The HF sparks will cause the electrode - workpiece gap to break down or ionise. Once an electron/ion cloud is formed, current can flow from the power source.

Note: As HF generates abnormally high electromagnetic emission (EM), welders should be aware that its use can cause interference especially in electronic equipment. As EM emission can be airborne, like radio waves, or transmitted along power cables, care must be taken to avoid interference with control systems and instruments in the vicinity of welding.

HF is also important in stabilising the AC arc; in AC, electrode polarity is reversed at a frequency of about 50 times per second, causing the arc to be extinguished at each polarity change. To ensure that the arc is reignited at each reversal of polarity, HF sparks are generated across the electrode/workpiece gap to coincide with the beginning of each half-cycle.

### WELDING GAS SELECTION CHART GUIDE

 <b>TIG</b> <b>TIG WELDING</b>	 <b>ARGON</b>	 <b>Ar-CO<sub>2</sub>-O<sub>2</sub></b>
	MILD STEEL	✓
STAINLESS STEEL	✓	✗
LOW ALLOY STEEL	✓	✗
ALUMINIUM	✓	✗

### APPLICATIONS

TIG is applied in all industrial sectors but is especially suitable for high quality welding. In manual welding, the relatively small arc is ideal for thin sheet material or controlled penetration (in the root run of pipe welds). Because deposition rate can be quite low (using a separate filler rod) MMA or MIG may be preferable for thicker material and for fill passes in thick-wall pipe welds.

TIG is also widely applied in mechanised systems either autogenously or with filler wire. However, several 'off the shelf' systems are available for orbital welding of pipes, used in the manufacture of chemical plant or boilers. The systems require no manipulative skill, but the operator must be well trained. Because the welder has less control over arc and weldpool behaviour, careful attention must be paid to edge preparation (machined rather than hand-prepared), joint fit-up and control of welding parameters.

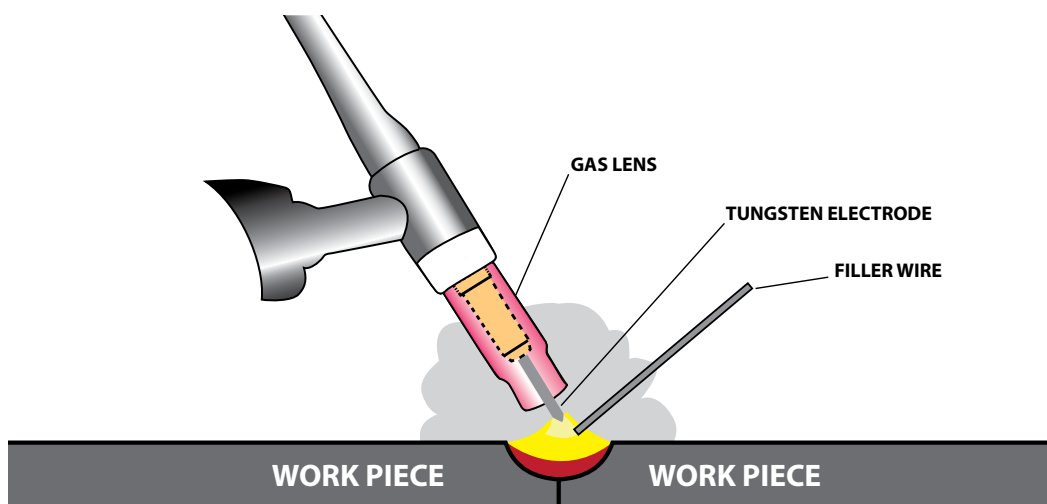

# BOSSWELD 26 SERIES 200AMP TIG TORCH SPARE PARTS

PART NO.	DESCRIPTION
95.26F.4.1.CC12A	Tig Torch 26, 4mt, 1 pc, Current control, Flexi Head
95.26F.8.1.CC12A	Tig Torch 26, 8mt, 1 pc, Current control, Flexi Head



PART NO.	DESCRIPTION
9957Y04	Back Cap Short
9557Y05	Back Cap Medium
955Y02	Back Cap Long



PART NO.	DESCRIPTION
9518CG	Torch Body Front Insulator
9554N01	Torch Body Front Insulator Lens Cup



PART NO.	DESCRIPTION
9510N21	Collet 0.5mm
9510N22	Collet 1.0mm
9510N23	Collet 1.6mm
9510N24	Collet 2.4mm
9510N25	Collet 3.2mm
9510N20	Collet 4.0mm



PART NO.	DESCRIPTION
9510N29	Collet Body 0.5mm
9510N30	Collet Body 1.0mm
9510N31	Collet Body 1.6mm
9510N32	Collet Body 2.4mm
9510N28	Collet Body 3.2mm
95406488	Collet Body 4.0mm



PART NO.	DESCRIPTION
9510N50	Alumin Cup Size 4
9510N49	Alumin Cup Size 5
9510N48	Alumin Cup Size 6
9510N47	Alumin Cup Size 7
9510N46	Alumin Cup Size 8
9510N45	Alumin Cup Size 10
9510N44	Alumin Cup Size 12

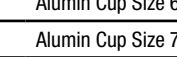

PART NO.	DESCRIPTION
95WP26	Torch Head
954WP26V	Torch Head with Valve
95WP26F	Flex Torch Head
95WP26FV	Flex Torch Head with Valve



PART NO.	DESCRIPTION
9545V24	Gas Lens Collet 1.0mm
9545V25	Gas Lens Collet 1.6mm
9545V26	Gas Lens Collet 2.4mm
9545V27	Gas Lens Collet 3.2mm
9545V28	Gas Lens Collet 4.0mm



PART NO.	DESCRIPTION
9554N18	Gas Len Alumin Cup Size 4 - 6.0mm
9554N17	Gas Len Alumin Cup Size 5 - 8.0mm
9554N16	Gas Len Alumin Cup Size 6 - 9.5mm
9554N15	Gas Len Alumin Cup Size 7 - 11.0mm
9554N14	Gas Len Alumin Cup Size 8 - 12.7mm
9554N19	Gas Len Alumin Cup Size 11 - 17.5mm

.....

**TROUBLE SHOOTING**

Issue	Possible Reason	Suggested Remedy
Power indicator is not lit, fan does not work and no output current	<ul style="list-style-type: none"> <li>• Welder is not plugged into power supply</li> <li>• Circuit breaker may have operated</li> <li>• Main power switch may not be in the ON position</li> </ul>	<ul style="list-style-type: none"> <li>• Check that the welder is plugged into the 240V mains outlet and is switched on.</li> <li>• Check that the mains fuse or breaker has not operated.</li> <li>• Check that the main switch on the rear of the unit is in the on position.</li> </ul>
Power indicator is lit, fan works, no output current	<ul style="list-style-type: none"> <li>• Output connectors may be disconnected or damaged</li> <li>• Welding cables or earth clamp not connected properly</li> </ul>	<ul style="list-style-type: none"> <li>• Check output connectors are connected properly and are not damaged</li> <li>• Check connections and that workpiece is free of paint and rust at connection point</li> </ul>
Over temperature indicator is on, no output current	<ul style="list-style-type: none"> <li>• Duty cycle of the unit has been exceeded.</li> </ul>	<ul style="list-style-type: none"> <li>• Allow the unit to cool for 20 minutes</li> </ul>
Output current is not stable.	<ul style="list-style-type: none"> <li>• Earth clamp connection loose</li> <li>• Mains Voltage is not constant</li> <li>• Loose welding cables</li> <li>• Leads reversed</li> </ul>	<ul style="list-style-type: none"> <li>• Check earth clamp is connected to work piece properly.</li> <li>• Change the Main Supply to an alternative</li> <li>• Check the welding connectors are tight in the sockets.</li> <li>• Check Leads are not reversed and correct +/-</li> </ul>
Hot Welding Clamp	Welding clamp rated current is too small,	Replace with larger size welding clamp.
Porosity - small cavities or holes resulting from gas pockets in weld metal	<ul style="list-style-type: none"> <li>• Wrong gas</li> <li>• Inadequate gas flow or too much gas flow</li> <li>• Moisture on the base metal</li> <li>• Contaminated base metal</li> <li>• Contaminated MIG wire</li> <li>• Loose gas connection</li> </ul>	<ul style="list-style-type: none"> <li>• Check that the correct gas is being used</li> <li>• Check the gas is connected; check hoses, gas valve and torch are not restricted. Set the gas flow between 10 - 15 l/min flow rate. Check hoses and fittings for holes, leaks etc. Protect the welding zone from wind and drafts</li> <li>• Remove all moisture from base metal before welding</li> <li>• Remove materials like paint, grease, oil, and dirt, including mill scale from base metal</li> <li>• Use clean dry rust free wire. Do not lubricate the wire with oil, grease etc.</li> </ul> <p>Check and tighten connection.</p>

## TROUBLE SHOOTING - CONTINUED

Issue	Possible Reason	Suggested Remedy
Lack of Fusion – failure of weld metal to fuse completely with base metal or a proceeding weld bead	<ul style="list-style-type: none"> <li>Contaminated base metal</li> <li>Not enough heat input</li> <li>Improper welding technique</li> </ul>	<ul style="list-style-type: none"> <li>Remove materials like paint, grease, oil, and dirt, including mill scale from base metal</li> <li>Select a higher voltage range and /or adjust the wire speed to suit</li> </ul> <p>Keep the arc at the leading edge of the weld pool. Gun angle to work should be between 5 &amp; 15° Direct the arc at the weld joint</p> <p>Adjust work angle or widen groove to access bottom during welding, Momentarily hold arc on side walls if using weaving technique</p>
Excessive Penetration – weld metal melting through base metal	<ul style="list-style-type: none"> <li>Too much heat</li> </ul>	<ul style="list-style-type: none"> <li>Select a lower voltage range</li> </ul>
Lack of Penetration – shallow fusion between weld metal and base metal	<ul style="list-style-type: none"> <li>Poor or incorrect joint preparation</li> <li>Not enough heat input</li> <li>Contaminated base metal</li> </ul>	<ul style="list-style-type: none"> <li>Material too thick. Joint preparation and design needs to allow access to bottom of groove while maintaining proper welding wire extension and arc characteristics</li> </ul> <p>Keep the arc at the leading edge of the weld pool and maintain the gun angle at 5 &amp; 15° keeping the stick out between 5-10mm</p> <ul style="list-style-type: none"> <li>Select a higher voltage range and</li> <li>Remove materials like paint, grease, oil, and dirt, including mill scale from base metal</li> </ul>
No gas flow	<ul style="list-style-type: none"> <li>Gas Regulator is off or pressure too low</li> <li>Something caught in the valve</li> <li>Solenoid valve is damaged,</li> </ul>	<p>Check Regulator</p> <ul style="list-style-type: none"> <li>Remove</li> <li>Contact BOSSWELD hotline</li> </ul>

## OPERATIONAL ENVIRONMENT

- Height above sea level  $\leq 1000\text{m}$
- Operation temperature range  $-10\sim+40^{\circ}\text{C}$
- Air relative humidity is below 90% (20°C)
- Preferably site the machine above floor level, ensure the maximum angle does not exceed 15 degrees.
- Protect the machine against heavy rain and against direct sunshine.
- The content of dust, acid, corrosive gas in the surrounding air or substance must not exceed normal standard.
- Take care that there is sufficient ventilation during welding. There must be at least 30cm free distance between the machine and wall.



## OTHER PRODUCTS IN OUR RANGE

- ELECTRODES
- TIG RODS
- WELDING HELMETS
- WELDING MACHINES
- TORCH SPARE PARTS
- WELDING ACCESSORIES
- MIG WIRE
- GAS EQUIPMENT
- WELDING SAFETY
- MIG TORCHES
- TIG TORCHES
- WELDING CABLE

**BOSSWELD**  
WELD LIKE A BOSS

*X series*