



# M210

PORTABLE LABEL PRINTER

USER MANUAL



# M210-LAB

PORTABLE LABEL PRINTER

## Copyright

This manual is copyrighted with all rights reserved. No portion of this manual may be copied or reproduced by any means without the prior written consent of BRADY.

While every precaution has been taken in the preparation of this document, BRADY assumes no liability to any party for any loss or damage caused by errors or omissions or by statements resulting from negligence, accident, or any other cause. BRADY further assumes no liability arising out of the application or use of any product or system described, herein; nor any liability for incidental or consequential damages arising from the use of this document. BRADY disclaims all warranties of merchantability of fitness for a particular purpose.

## Trademarks

M210 Label Printer is a trademark of BRADY Worldwide, Inc.

M210-LAB Label Printer is a trademark of BRADY Worldwide, Inc.

Microsoft and Windows are registered trademarks of Microsoft Corporation.

All brand or product names referenced in this manual are trademarks (™) or registered trademarks (®) of their respective companies or organisations.

© 2022 BRADY Worldwide, Inc. All Rights Reserved.

Firmware 3.0

Brady Worldwide, Inc.  
6555 West Good Hope Road  
Milwaukee, WI 53223  
[bradyid.com](http://bradyid.com)

## BRADY Warranty

Our products are sold with the understanding that the buyer will test them in actual use and determine for him or herself their adaptability to his/her intended uses. BRADY warrants to the buyer that its products are free from defects in material and workmanship, but limits its obligations under this warranty to replacement of the product shown to BRADY's satisfaction to have been defective at the time BRADY sold it. This warranty does not extend to any persons obtaining the product from the buyer.

THIS WARRANTY IS IN LIEU OF ANY OTHER WARRANTY, EXPRESSED, OR IMPLIED INCLUDING, BUT NOT LIMITED TO ANY IMPLIED WARRANTY OF MERCHANTABILITY OR FITNESS FOR A PARTICULAR PURPOSE, AND OF ANY OTHER OBLIGATIONS OR LIABILITY ON BRADY'S PART. UNDER NO CIRCUMSTANCES WILL BRADY BE LIABLE FOR ANY LOSS, DAMAGE, EXPENSE OR CONSEQUENTIAL DAMAGES OF ANY KIND ARISING IN CONNECTION WITH THE USE, OR INABILITY TO USE, BRADY'S PRODUCTS.

YOU SHOULD CAREFULLY READ THE FOLLOWING TERMS & CONDITIONS OF THIS LICENSE AGREEMENT. IF YOU DO NOT AGREE WITH THESE TERMS & CONDITIONS, PLEASE PROMPTLY RETURN THIS PACKAGE FOR A FULL REFUND.

## Technical Support and Registration

### Contact Information

For repair or technical assistance, locate your regional Brady Technical Support office by going to:

- **United States:** [bradyid.com/techsupport](https://bradyid.com/techsupport)
- **Canada:** [bradycanada.ca/contact-us](https://bradycanada.ca/contact-us)
- **Mexico:** [bradyid.com.mx/es-mx/contacto](https://bradyid.com.mx/es-mx/contacto)
- **Latin America:** [bradylatinamerica.com/es-mx/soporte-técnico](https://bradylatinamerica.com/es-mx/soporte-técnico)
- **Europe:** [bradyeurope.com/services](https://bradyeurope.com/services)
- **Australia:** [bradyid.com.au/technical-support](https://bradyid.com.au/technical-support)
- **Asia Pacific:** [brady.co.uk/landing-pages/global-landing-page](https://brady.co.uk/landing-pages/global-landing-page)

### Registration Information

To register your printer go to:

- [bradyid.com.au/register](https://bradyid.com.au/register)

### Repair and Return

If for any reason you need to return the product for repair, please contact Brady Technical Support for repair and replacement information.

# Contents

## 1 • Introduction

Unpack Your Printer .....	2
Accessories .....	2
Register Your Printer .....	2
System Specifications .....	3
Physical and Environmental Characteristics .....	3
<b>External View .....</b>	<b>4</b>
<b>Power Source.....</b>	<b>5</b>
Battery Safety .....	5
Loading AA Alkaline Batteries .....	7
Loading the Lithium Ion Battery Pack .....	8
Remove Lithium Battery .....	9
AC Power Adapter .....	10
Attaching the Adapter .....	10
Charging the Lithium Ion Battery Pack .....	11
<b>Media Cartridge.....</b>	<b>12</b>
Changing the Label Cartridge .....	13
Recycling the Label Cartridge .....	14
Materials .....	14
<b>Power On .....</b>	<b>15</b>
Printer Version .....	15
Editing Screen .....	16
Status Information .....	16
<b>Keypad.....</b>	<b>17</b>
Navigation and Editing Keys .....	17
Function Keys .....	19
<b>Menus .....</b>	<b>20</b>
Data Fields .....	21
Cancel a Menu or Data Field .....	21
Printer Defaults .....	22
Language .....	22
Initial Language Setup .....	23
Set Clock .....	23
Units .....	27
Cut Mode .....	28
Set Zero Style .....	29
Backlight Time .....	30
Cartridge .....	30
About .....	31

## 2 • Getting Started

<b>Entering Text.....</b>	<b>32</b>
Editing Text .....	32

Inserting Text .....	32
Deleting Text .....	33
Clear Data .....	33
Cancel Functions .....	33
Error Messages .....	33
Font Size .....	34
Printing a Label .....	35
Multi-Print .....	35
<b>3 • Formatting</b>	
<b>Symbols.....</b>	<b>36</b>
Remove a Symbol .....	37
International Character Set .....	38
Date and Time .....	39
Timestamp .....	39
Barcode .....	40
Add a Barcode .....	40
Datamatrix and QR Codes .....	41
Add a Datamatrix or QR Code .....	41
<b>Serialisation.....</b>	<b>43</b>
How Serialisation Works .....	43
Examples of Serialisation .....	43
Using Letters in Serialisation .....	44
Multi-Letter Serialisation .....	44
Add Serialisation .....	45
<b>4 • File Management</b>	
<b>File Naming Standards.....</b>	<b>46</b>
Save a File .....	46
Replace (Overwrite) a File .....	47
Open a File .....	48
Delete a File .....	49
<b>5 • Label Types</b>	
<b>Selecting a Label Type.....</b>	<b>50</b>
<b>Banner Portrait Label Type.....</b>	<b>51</b>
<b>Banner Landscape Label Type.....</b>	<b>52</b>
<b>Fixed Length .....</b>	<b>53</b>
<b>Custom Length .....</b>	<b>54</b>
<b>Vial .....</b>	<b>55</b>
<b>WireMarker Label Type (M210).....</b>	<b>56</b>
<b>Terminal Block, Patch Panel (M210).....</b>	<b>58</b>
<b>Panel Residential (M210).....</b>	<b>61</b>
<b>Flags (M210).....</b>	<b>63</b>
<b>Breaker Box (M210).....</b>	<b>65</b>
<b>6 • Troubleshooting</b>	

---

<b>Cleaning the Printer</b> .....	<b>75</b>
Display Screen .....	75
Internal Components .....	75
<b>A • Symbols</b>	
<b>Assorted</b> .....	<b>76</b>
<b>Miscellaneous</b> .....	<b>77</b>
<b>Miscellaneous (Russian only)</b> .....	<b>77</b>
<b>Greek</b> .....	<b>78</b>
<b>Lab</b> .....	<b>79</b>
<b>B • Supported ASCII Characters</b>	
<b>Barcodes</b> .....	<b>80</b>
Code 39 .....	80
Code 128 .....	80
Datamatrix and QR Codes .....	80
<b>C • Regulatory Compliance</b>	
<b>Agency Compliance and Approvals</b> .....	<b>81</b>

# 1 Introduction

---

The M210/M210 LAB Label Printer is a rugged, highly mobile printer designed to print on a variety of continuous and pre-sized materials. With label widths from .25" to .75"(6.35mm - 19.1mm), this labeler meets the demands of rigorous job sites printing up to 100 labels per day. Key features include:

- Pre-loaded application design guides to simplify label creation for common application types.
- Ability to store up to 12 files for rapid access to your repeated label types
- On board ability to create UPC, DataMatrix, and QR Codes
- Drop-Lock-Print style cartridges for easy media changes
- 20 on-board language options
- Ability to power the printer through 6 AA batteries, optional rechargeable lithium ion battery pack (sold separately), or optional AC power adapter (sold separately).
- Battery Life Expectations: a minimum of 1,800 2 inch long labels on 6 AA alkaline batteries; a minimum of 2,000 2 inch long labels on the lithium ion battery pack
- 203 DPI print resolution

**Note:** The M210 and M210-LAB Label Printers differ only in the available label type templates. The M210-LAB is intended for use in laboratory environments and therefore presents only label types for laboratory functions.

The M210 also comes in a Russian language version with a Cyrillic keypad.



## Unpack Your Printer

The following items are included in the standard M210/M210-LAB Label Printer package:

- M210 Label Printer (M210-LAB Label Printer)
- M21-750-499 0.75" (19.1 mm) Multi-Purpose White Nylon Cartridge with the M210  
*or*  
M21-750-7425 Chemical and Temperature Resistant Label Cartridge with the M210-LAB
- Quick Start Guide



## Accessories

The following items are accessories available for the M210/M210-LAB Label Printers.

- Lithium Ion battery pack (M210-BATTERY)
- AC Adapter 110V (M210-AC), 220V (#110416), UK 240V (#110417)
- Hardside carrying case (M210-HC)
- M210 Printer Soft Case (BMP-SC-1)
- Magnet Accessory (M21-MAGNET)
- Multifunctional Accessory Multi-Tool Accessory (M210-TOOL)
- Belt clip accessory (M21-CLIP)
- Power Source Kit; AC Adapter and Lithium Ion Battery (M210-PWRKIT)

Accessories can be purchased separately or potentially as part of a kit. A variety of kits are available in different areas. Please visit your local Brady website to determine what kits are available in your country/region.

## Register Your Printer

Register your printer on-line at [www.bradyid.com.au/register](http://www.bradyid.com.au/register) and receive free product support and updates!

For Warranty information, visit your local Brady website.

## System Specifications

The M210/M210LAB Label Printer has the following specifications:

- Weight 1.66 lbs (0.753 kg)
- Thermal Transfer Print Mechanism, 203 DPI print resolution
- Softplast ABC-style keypad
- Print Width - 0.75-inch (19.1 mm) maximum label width
- Maximum length for labels with alphanumeric characters: 99.9 inches (253.7 cm)
- Maximum characters that can be printed: 50
- Prints up to 1800 1/2-inch x 2-inch (12.7mm x 50.8mm) labels on 6 AA batteries

## Physical and Environmental Characteristics

The M210/M210-LAB Label Printer has the following physical and environmental characteristics:

Physical	Metric Units	Imperial/U.S. Units
Dimensions	243.84 x 63.5 x 124.46 mm	9.6" x 2.5" x 4.9"
Weight (with battery pack)	0.75 kg	1.66 lbs

**Note:** The table below refers to the M210/M210-LAB Label Printer only. Consumable performance may vary.

Environmental	Operation	Storage
Temperature* (Printer)	4° to 43° C (40° to 110° F)	-18° to 43° C (0° to 110° F)
Relative Humidity (Printer)	20% to 90% (non-condensing)	10% to 90% (non-condensing)

\*Exposing the printer to direct sunlight is not recommended.



**WARNING!** Avoid using the system near water, in direct sunlight, or near a heating device.



**WARNING!** Do not expose batteries to temperatures above 60° C (140° F).

Batteries give their best performance when they are operated at normal room temperature (20 °C ± 5 °C, 68°F ± 41°F).

## External View



- |  |  |
|--|--|
| <ul style="list-style-type: none"> <li>1 Power key</li> <li>2 Function keys</li> <li>3 Symbols and characters</li> <li>4 Secondary function key</li> <li>5 Navigation pad with ENTER key</li> <li>6 Set language and unit defaults</li> <li>7 Print key</li> </ul> | <ul style="list-style-type: none"> <li>8 Cutter lever</li> <li>9 Cartridge bay locking lever</li> <li>10 Cartridge bay with cartridge</li> <li>11 AC adapter port</li> <li>12 Cartridge eject button</li> <li>13 Battery compartment</li> <li>14 Finger tabs on battery compartment cover</li> </ul> |
|--|--|

**Note:** There are NO PC connection ports on the printer, therefore it CANNOT be connected to a PC.

## Power Source

Power is supplied to the printer by six AA alkaline batteries, a Lithium Ion (Li-Ion) battery pack, or by an AC power adapter.

To maintain maximum printer performance use basic AA alkaline batteries, NOT rechargeable or Ultimate Lithium AA batteries.

The optional Li-Ion battery pack is rechargeable, but must be removed from the printer and attached to the AC power adapter for charging to take place.

The AC power adapter is used to recharge the Li-ion battery pack outside the printer, but it can also be used to power the M210 printer without batteries.

### **Battery Safety**



**WARNING!** Do not attempt to use batteries other than those recommended in this manual.



**WARNING!** The M210 battery pack needs to be charged before use. ALWAYS use the correct charger and refer to the manual included with the pack.

Do not disassemble or mistreat the battery pack.

Do not attempt to open, damage, or replace components in the battery pack.

The battery pack should only be used in the M210/M210-LAB Label Printers and only the battery pack supplied for these printers should be used.

Keep the battery pack away from sparks, flames, or other heat sources.

Keep the battery pack away from water.

Never lay objects on top of the battery pack.

Store your battery pack only in a cool, dry place.

Keep the battery pack out of the reach of children.

The battery pack must be recycled or disposed of properly according to federal, state, and municipal regulations.



**WARNING!** Do not allow metal or other conductive materials to touch the battery terminals.

Do not dismantle, open, or shred cells or batteries.

Do not expose cells or batteries to heat or fire. Avoid storage in direct sunlight.

Do not short-circuit a cell or a battery. Do not store cells or batteries haphazardly in a box or drawer where they may short-circuit each other or be short-circuited by other metal objects.

Do not remove a cell or battery from its original packaging until required for use.

Do not subject cells or batteries to mechanical shock.

In the event of a cell leaking, do not allow the liquid to come in contact with the skin or eyes. If contact has been made, wash the affected area with copious amounts of water and seek medical advice.

Do not use any charger other than that specifically provided for use with the equipment.

Observe the plus (+) and minus (-) marks on the cell, battery and equipment and ensure correct use.

Do not use any cell or battery which is not designed for use with the equipment.

Do not mix cells of different manufacture, capacity, size, or type.

When using alkaline cells, always use fresh, new batteries and never mix used batteries with new batteries.

Seek medical advice immediately if a cell or a battery has been swallowed.

Keep cells and batteries clean and dry.

Wipe the cell or battery terminals with a clean dry cloth if they become dirty.

After extended periods of storage, it may be necessary to charge the battery pack to obtain maximum performance.

Retain the original product literature for future reference.

## Loading AA Alkaline Batteries

On the back of the printer, squeeze the finger tabs located on both sides of the battery compartment door, then swing the battery compartment door up and out. (The door will come off.)

Insert 6 AA alkaline batteries, observing correct polarity. (Do not use rechargeable AA batteries or Ultimate Lithium AA batteries).

Re-insert the battery door hinge at the top of the compartment and push down on the battery compartment door, snapping it into place.



## Loading the Lithium Ion Battery Pack

When using an M210-BATTERY Lithium Ion battery pack, please consult the instructions enclosed with the battery pack for the charging procedure.

On the back of the printer, squeeze the finger tabs located on both sides of the battery compartment door, then swing the battery compartment door up and out. (The door will come off.)

With the battery label facing down, insert the elongated portion of the battery (just below the alignment tabs) into the slot at the bottom of the battery compartment; then push the top part of the battery down until it snaps into place. (The battery alignment tabs fit into the cutout finger tab grooves.)

Re-insert the battery door hinge at the top of the compartment and push down on the battery compartment door, snapping it into place.



## Remove Lithium Battery

Squeeze the finger tabs located on both sides of the battery compartment door, then swing the battery compartment door up and out. (The door will come off.)

Placing your thumb at the base of the printer, use your forefingers to gently pull up on the raised portion of the battery. This releases the top of the battery from the contacts.

Grasp the raised battery and pull it up and out from the bottom contact slots.





## AC Power Adapter

The printer can be powered by an AC/DC power adapter. The AC/DC power adapter can also be used to recharge the M210-BATTERY battery pack outside of the printer.



**WARNING!** Use only the 9V DC, Brady AC/DC adapters, shown below, for supplying power to the M210/M210-LAB Label Printers.

### *Attaching the Adapter*

The printer can be powered through a designated AC power adapter.

**Note:** The lithium ion battery does NOT charge within the printer when using the AC adapter.

Insert the round end of the optional adapter cable into the plug-in port on the left side of the printer.

Plug the other end of the cord into an electrical outlet.



### ***Charging the Lithium Ion Battery Pack***

The lithium ion battery pack accessory cannot be charged in the printer. The battery pack must be removed from the printer and charged using the M210-AC AC adapter. To use the printer while charging the battery, insert 6 AA alkaline batteries in the battery compartment.

#### **Attaching the Adapter to the Battery Pack**

1. Insert the round end of the adapter cable into the plug-in port on the lower left side of the battery pack.
2. Plug the other end of the adapter cord into an electrical outlet.

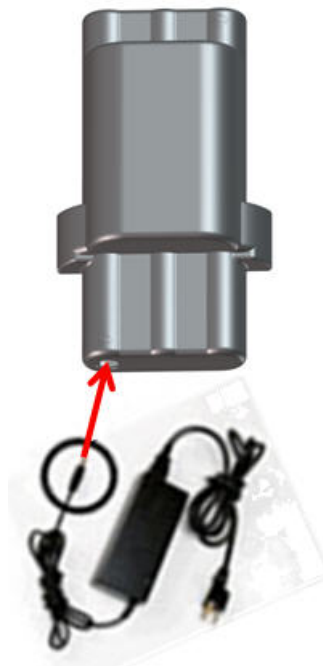



## Media Cartridge

The M21 media and ribbon supplies are combined in a plastic cartridge for easy one-step loading and have been optimized for the M210/M210-LAB Label Printers. Cartridges are offered as continuous tapes between 0.25" - 0.75" (6.35mm - 19.1mm) or as pre-sized labels in multiple material types.

**Note:** For specific compatibility with older Brady Label Printers, please refer to information provided for each individual catalog number.

Media types include:

	
<p>Multi-Purpose</p>	<p>Heat Shrink</p>
	
<p>Wire Marking</p>	<p>Pre-Sized</p>

## Changing the Label Cartridge

To unlock the cartridge, turn the locking lever left to the horizontal position.

Push the eject button on the back of the printer, then lift the cartridge out of the printer.

Place a new cartridge in the cartridge bay and push down until the cartridge snaps into place.

Turn the locking lever right to the vertical position.



Locking Lever (locked)



Eject Button



Locking Lever (unlocked)

If the cartridge is empty, recycle according to local regulations. (See [page 14](#) for more information on recycling cartridges.)

Store the cartridge in a cool, dry place.

**Note:** The cartridge bay contains parts and assemblies that may be susceptible to damage by Electrostatic Discharge (ESD). When loading or unloading a cartridge, care must be taken so that devices are not damaged.

## Recycling the Label Cartridge

Cartridges need to be recycled in accordance with local regulations. Before recycling, the used cartridges must be pulled apart to release the individual components. These various components must then be recycled in the correct recycling bins.

### Materials

- 1/4-inch blade flathead screwdriver
- Safety Glasses
- Safety Gloves



**CAUTION! ALWAYS wear Personal Protective Equipment when dismantling a cartridge.**

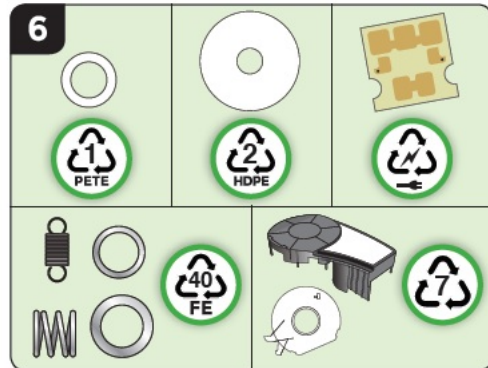
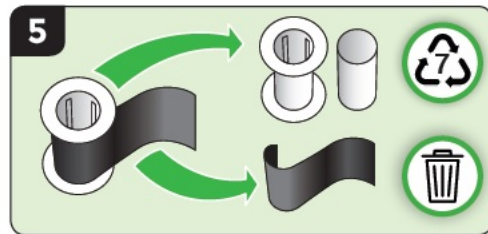
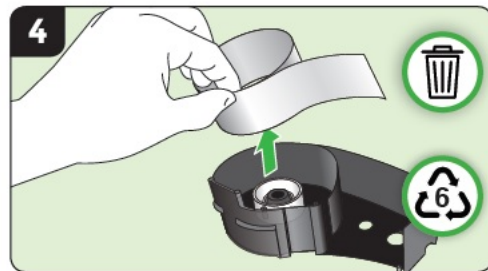
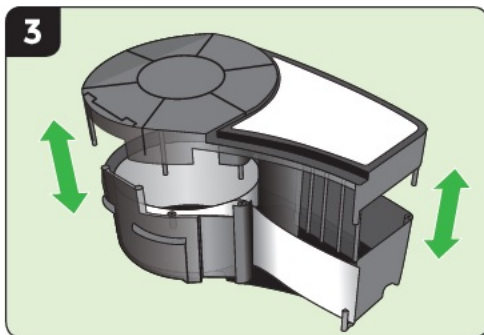
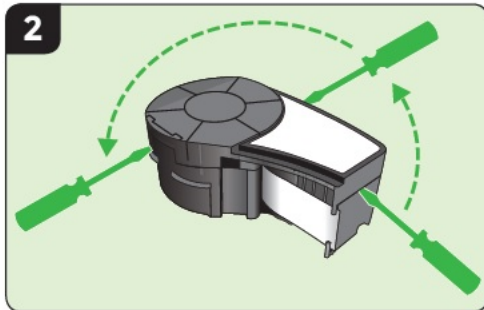
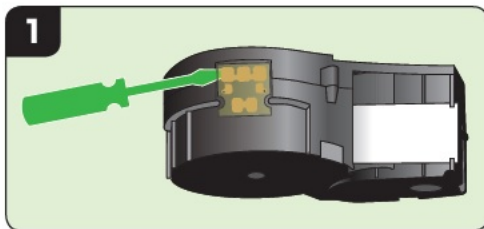

## Power On

### Printer Version

To turn the system on or off:

1. Press **Power**  .
2. Watch the screen closely for the version number which displays briefly.

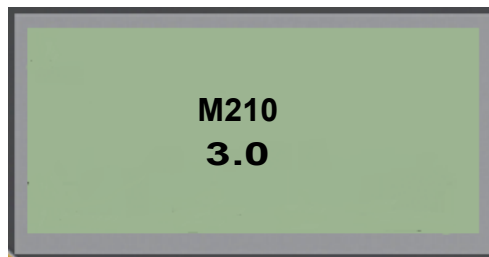

**Note:** Screen shown above is a sample only; version number on your product may differ.

If you missed seeing the version number and need to know what it is:

3. Remove whichever type of batteries are installed.
4. Press and hold the power button for 10 seconds.
5. Reinstall batteries while watching the screen.

If using the power adapter instead of batteries:

6. With the printer powered up, remove and reinsert the power adapter into the plug-in port on the left side of the printer while watching the screen.

To preserve battery life, when the printer detects a time of inactivity, it automatically shuts down. Any data on the screen at the time of auto shutdown is retained and available the next time the [Power] key is pressed to restart the printer.

The first time the printer is turned on, you may want to choose a language in which to display screen items. Language selection is obtained from the Menu function. (For more information, see “Selecting a Language” on [page 22](#).)

Whenever the printer is powered on, the system performs an initialization process. Part of this process is recognizing the media installed. While it is possible to power on the printer without installing media, you must insert a media cartridge in order to continue.

## Editing Screen

The editing screen enables you to view formatting features directly on the screen while you are entering and editing data.

### Status Information



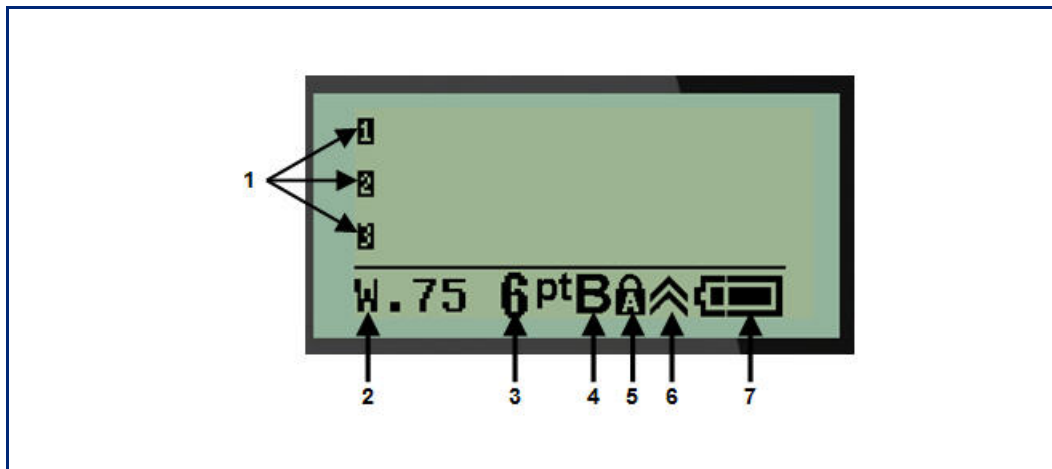



A status bar displays permanently at the bottom of the screen and contains the following:





- |   |   |
|---|---|
| <ul style="list-style-type: none"> <li>1 Text lines</li> <li>2 Label type</li> <li>3 Font size</li> <li>4 Bold font (on)</li> </ul> | <ul style="list-style-type: none"> <li>5 Caps lock (on)</li> <li>6 Function key indicator (in use)</li> <li>7 Battery life indicator</li> </ul> |
|---|---|

# Keypad

## Navigation and Editing Keys

Function	Key	Description
Power		Turns on the printer
Navigation Keys		<p>Navigation keys:</p> <ul style="list-style-type: none"> <li>In a line of text, move the cursor left or right a character at a time, or up and down a line at a time.</li> <li>In menus, move the selection up or down in primary menu choices; left or right through secondary menu choices (such as Symbols or International characters), if available.</li> </ul>
ENTER Key		<ul style="list-style-type: none"> <li>Adds a new blank line in label data.</li> <li>Accepts menu selections and attributes.</li> </ul>
Alternate Function Key		<ul style="list-style-type: none"> <li>Used in conjunction with the alternate function (displayed in gold) on the keys. Press the alternate function key, then press the key.</li> </ul> <p>OR</p> <p>Hold the alternate function key while simultaneously pressing the key that has the alternate function.</p> <ul style="list-style-type: none"> <li>Used to access special characters on the alphanumeric keys.</li> </ul>
Backlight Key		Increases readability of screen in low light conditions.
Backspace Key		<ul style="list-style-type: none"> <li>Removes characters one at a time, moving to the left.</li> <li>Backs out of menu options and functions, one screen at a time.</li> </ul> <p>Note: Depending on how deep you are into menus and functions, you may have to press Backspace multiple times.</p>



Function	Key	Description
Caps Lock Key		Acts as a toggle to lock text into uppercase as data is entered.
Clear Key		Clears data from the screen.
Decimal Point		Adds a decimal point or period.

## Function Keys

Function	Key	Description
Feed Key		Feeds the media through the printer.
Serial Key		Sets the start, end, and increment values for serialisation.
Menu Key		Provides printer defaults (i.e., language, units) and other print options not available on keys. Menu items include symbols, international characters, barcode styles, and file options.
Label Type Key		Accesses the different applications/label type templates installed (i.e., wiremarker, banner, terminal blocks, etc.).
Font Size Key		Provides font sizes and bold attribute.
Print Key		Prints all labels in a label file.
Multi-Print Key		Prints multiple copies of a label.
Symbol Key		Accesses the predefined graphics (symbols) available in the printer.
Barcode Key		Places a text string in Barcode format.
International Key		Accesses characters specific to some international alphabets with diacritical and accent marks incorporated into the characters.
Add Date Key		Inserts the current date, as set on the printer.
Add Time Key		Inserts the current time, as set on the printer.

## Menus

Additional functions not displayed on a key are available from the Menu key. Use the up or down navigation keys to access the different menu items displayed. When you have reached the last menu item displayed, the menus cycle back to the first menu item.

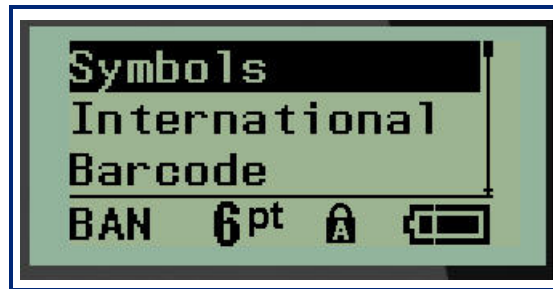

To access the menus:

1. Press **MENU**.

The menu choices display in a list.

2. Press the up/down navigation keys to highlight the menu items.

3. Press **Enter**  to select the menu item.

To exit a menu without selecting it:

4. Press **Backspace** .

The various key functions and menu items are discussed in further detail in the Formatting section of this manual, starting on [page 36](#).

## Data Fields

For some menu items, there may be data fields requesting additional information. To enter the information:

1. Using navigation keys, navigate to the data field.
2. Enter data using the keyboard.  
OR  
Use the left/right navigation keys to toggle through a series of predesigned values.
3. Use navigation keys to move off the field after entering data.
4. To accept data entered, press **Enter** .



## Cancel a Menu or Data Field

To cancel a menu or data field, without accepting changes:

Press **Backspace** .

## Printer Defaults

Printer defaults are set to provide a consistent operating environment for the work you do with your printer. Once the defaults are set, they will remain in effect until you change them. The following printer default settings can be found using the Menu key.

- Language
- Units
- Set Clock
- Cut Mode
- Set Zero Style
- Backlight Time

### *Language*

The following languages can be found under the Language menu item.

**Note:** Quick Start Guides are available electronically for all languages listed on the printer.

#### **M210 Languages**

English - Default	Czech	Romanian
French	Danish	Slovakian
Spanish	Estonian	Slovenian
German	Finnish	Swedish
Dutch	Hungarian	Turkish
Portuguese	Norwegian	Croatian
Italian	Polish	

#### **M210-Lab Languages**

English - Default	Dutch
French	Portuguese
Spanish	Italian
German	

#### **M210 Russian Languages**

Russian - Default  
English

**Note:** Greek language characters are found under the International menu function.

### Initial Language Setup

When turning the printer on for the first time, immediately go to the Menu>Language function and choose the language in which you want all printer menus, functions, and data displayed.

1. Press **MENU**.
2. Using navigation keys, choose **Language**.

**Note:** The menu item “Language” is the 6th item in the menu list and the word “Language” displays in the language that is currently set on your printer. For instance, in English it displays “Language,” in Spanish it displays “Idioma,” in French it displays “Langue,” etc.

3. Press **Enter** .
4. Using navigation keys, choose the desired language, then press **Enter**.

### Set Clock

The following settings can be found under the Set Clock menu function. Set the Date and Time options upon initial start-up of the printer.

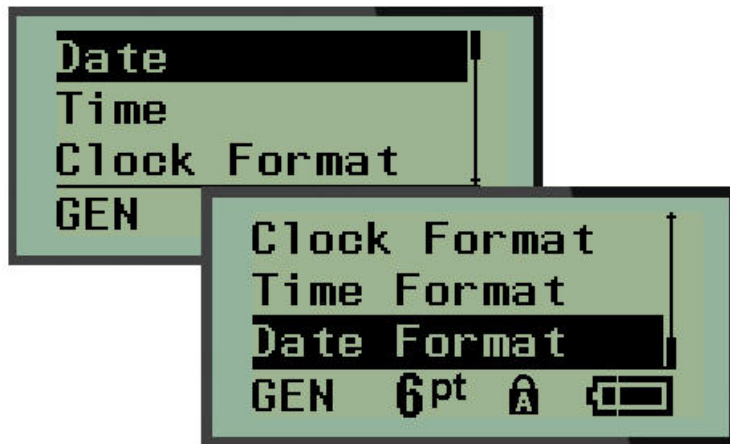

**Clock Format**

Before setting the date and time, set the Clock Format. This enables you to use a 12-hour clock or a 24-hour clock. To set the Clock Format:

1. Press **MENU**.
2. Navigate to Set Clock, then press **Enter** .
3. Navigate to Clock Format, then press **Enter**.

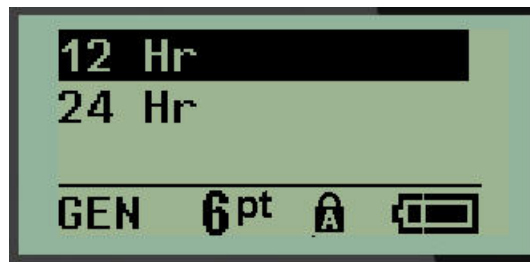

4. Select the desired format, then press **ENTER**.

**Date Format**

You have four choices for the date format. The date can be displayed in the American standard (MM/DD/YY) or the International Standard (DD/MM/YY). You can also have the date display 2 digits or 4 digits for the year (e.g., YY = 22, YYYY = 2022). To set the date:

1. Press **MENU**.
2. Navigate to Set Clock, then press **Enter** .
3. Navigate to Date Format, then press **Enter**.



4. Select the desired format, then press **Enter**.

### Time Format

Next, choose the Time Format to use. The Time Format displays the time in hours and minutes, or hours, minutes, and seconds. To set the time:

1. Press **MENU**.
2. Navigate to Set Clock, then press **Enter** .
3. Navigate to Time Format, then press **Enter**.



4. Select the desired format, then press **Enter**.

### Set Date

Once you have set the date and time format, you can now set the actual date and time.

To set the date:

1. Press **MENU**.
2. Navigate to Set Clock, then press **Enter** .
3. Navigate to Date, then press **Enter**.
4. Navigate to various fields to set the desired month, day, and year for the time you want displayed on your labels.

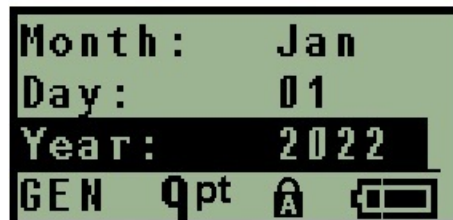

5. Enter the date from the keyboard OR use the left/right navigation key to decrease or increase the date, one month, day, or year at a time. (The left navigation key decreases the number, the right navigation key increases the number.)
6. When finished setting the date, press **Enter**.



## Set Time

To set the time:

1. Press **MENU**.
2. Navigate to Set Clock, then press **Enter** .
3. Navigate to Time, then press **Enter**.
4. Navigate to various fields to set the hour and/or minutes of the desired time.



**Note:** When using the time format HH:MM:SS, no field for seconds displays. The internal clock in the printer starts the seconds based on the minutes you have chosen.

5. Enter the time from the keyboard OR use the left/right navigation key to decrease or increase the time, one hour or minute at a time. (The left navigation key decreases the time, the right navigation key increases the time.)

**Note:** If you have chosen the 12 hour clock format, you can toggle the Clock field between AM and PM. If you have chosen the 24 hour clock format, you will not be able to access the Clock field.

6. When finished setting the time, press **Enter**.

The date and time format and date and time are stored on the printer and will automatically increment forward to the current date or time whenever the printer is used. The date and time format you have chosen only displays when the date or time function is used. You can enter any date or time, in any format, from the keyboard. Entered data is not affected by the internal clock.

## Units

The Units setting is used to configure label parameters for the printer. The units are:

- Inches
- Millimeters

Once configured, you do not have to indicate “inches” or “millimeters” (or their globally accepted abbreviations or marks) when entering numbers in data fields. Likewise, in any scale or range of measurement field (as found under Label Type), the range of measurements will automatically configure to the units selected in the Menu function.

To set the default units:

1. Press **MENU**.
2. Navigate to Units, then press **Enter** .



3. Navigate to the desired units of measure, then press **Enter**.

## Cut Mode

Set the Cut Mode default to determine when the printer should pause for cutting. There are two modes to choose from:

- Cut Between Labels
- Cut at End of Job

In a multiprint job (serialised label, terminal block, breaker box, etc.) cut mode determines if the printer should pause between each label for cutting the individual labels. If you select Cut at End of Job, all labels in a serialised sequence, or all labels for each listed block in a terminal or breaker box label type, will print out as one long string, pausing for cutting only after the last label has been printed.

To set the Cut Mode:

1. Press **MENU**.
2. Navigate to Cut Mode, then press **Enter** .
3. Navigate to the desired cut mode, then press **Enter**.



## Set Zero Style

The Set Zero Style default determines if the number zero will print as an open zero (0), or intersected by a line (Ø), as on a computer. To set the Zero Style default:

1. Press **MENU**.
2. Navigate to Set Zero Style, then press **Enter** .

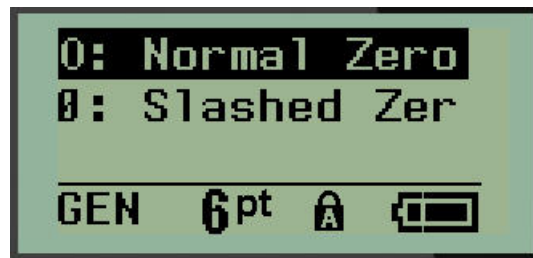

3. Navigate to the desired zero style, then press **Enter**.

## Backlight Time

The Backlight Time sets the backlight auto-off time-out. This refers to the number of seconds of inactivity detected, after which the backlight automatically shuts off.

If you prefer to keep the backlight on at all times while using the AC adapter, choose Always On. To turn it off completely, select Always Off. Otherwise set the number of seconds of inactivity the printer should detect before shutting off the backlight. The options run from 5 seconds to 30 seconds, at 5-second intervals.

To reset the Backlight options:

1. Press **MENU**.
2. Navigate to Backlight Time, then press **Enter** .



3. Navigate to the desired backlight options, then press **Enter**.

## Cartridge

The Cartridge function provides a visual indicator of the amount of supply left in the cartridge.

1. Press **MENU**.
2. Navigate to Cartridge, then press **Enter** .

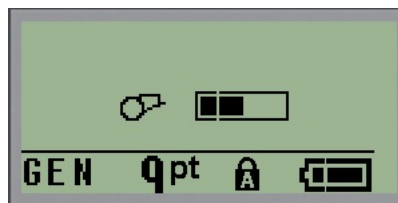

## About

About identifies the printer type and the version of firmware installed.

1. Press **MENU**.
2. Navigate to About <printer name>, then press **Enter** .

## 2 Getting Started

---

This section describes the process of creating a text label with minimal formatting, using basic editing techniques, and printing the label.

### Entering Text

Before entering label text, be sure the media cartridge is loaded and the power is ON.

The vertical bar on the display screen is the cursor and is the starting point for every label you create. Begin entering text at the position of the cursor. The cursor moves across the screen as you enter data. If you want another line of text, press [ENTER] .

### Editing Text

If you have entered some text in error or want to change the content or format of your label, edit the information before printing.

### *Inserting Text*

To insert additional text within a line of text:

1. Using navigation keys, position the cursor at the point where text should be inserted.
2. Enter the text.

Existing data positioned to the right of the cursor moves progressively to the right to make room for the inserted text. When the end of the line (for the label size) is reached, no more data can be inserted. The error message “Cannot Fit” displays to indicate that the width of the label cannot accommodate any more text.



To correct the error, delete some of the text, add another line of text, or decrease the font size.

## Deleting Text

To remove characters, one at a time, from the position of the cursor TO THE LEFT (backwards):

Press **Backspace** .

If you want to delete characters in the middle of the line of text, use the navigation keys to position the cursor to the right of the characters you want to delete, then press [BACKSPACE].

## Clear Data

The Clear key is used to clear all data from the screen.

To clear data:

Press **CLEAR**  + .

Clear removes all data on the label, but leaves the formatting in place (e.g., font size, label type, etc.)

## Cancel Functions

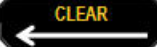
Backspace  is also used to cancel functions or a menu. When pressing [BACKSPACE] in the middle of a function, you are walked out of the function a screen at a time. You may have to press [BACKSPACE] several times to completely exit the function.

## Error Messages

If a function does not operate under current conditions, an error or information message displays indicating the problem and/or offers situational advice. Read the message carefully and follow the instructions. (A list of error messages can be found in the Troubleshooting section of this manual, starting on [page 67.](#))



## Font Size

**Note:** This printer provides a single typeface – the Brady Fixed Width Condensed typeface – that has different sizes and weights.

Font size can be applied before or after data is entered, regardless of where the cursor is positioned. The font setting applies to all text on the label. You cannot change font size on individual lines of text.

The following font sizes are available:

Auto	Auto Bold
6	<b>6 Bold</b>
9	<b>9 Bold</b>
14	<b>14 Bold</b>
20	<b>20 Bold</b>
28	<b>28 Bold</b>
40	<b>40 Bold</b>

To change the font size:

1. Press **FONT SIZE**.
2. Navigate to the desired font size and weight, then press **Enter** .

## Autosize

Autosize starts with the largest font size that fits on the label. When a line of text reaches the fixed margin (distance between the edge of the print head and the cutter blade), it scales downward until you press [ENTER] or the minimum font size is reached.

By default, a 9 point font is enabled for all labels. To turn autosize on:

1. Press **FONT SIZE**.
2. Navigate to **Auto**, then press **Enter** .

When autosize is turned on, it displays as an 'A' in the Status Bar. Autosize remains on for the entire label, until a different font size is selected.



## Printing a Label

To print a label:

1. Press **PRINT**.

A printing icon displays on the screen indicating that the label is printing and displays the amount of media left in the cartridge. When the icon disappears, you can cut the label.

2. Squeeze the cutter levers to cut the label.

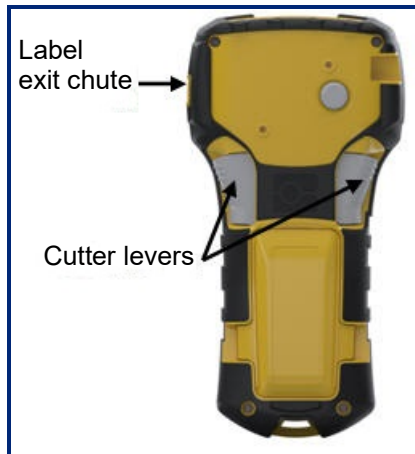



The label exit chute contains plastic grips that hold the label in place after cutting so it will not fall off.

3. Gently pull the label away from the label exit chute.

### Multi-Print

Multi-Print allows you to print multiple copies of a label file. You have the option to print then cut each label or to print all labels then cut. To print multiple copies:

1. Press **MULTI-PRINT**  + **MULTI-PRINT PRINT**.
2. In the *Copies:* field, enter a numeric value for the number of copies desired OR use left/right navigation keys to decrease or increase the number of copies.
3. When ready, press **Enter** .
4. Either press the cutter levers between labels or press the print button to print the next label without cutting.

## 3 Formatting

Formatting refers to the layout, structure, and appearance of a label. Different formatting features can be found under the Menu and function keys.

### Symbols

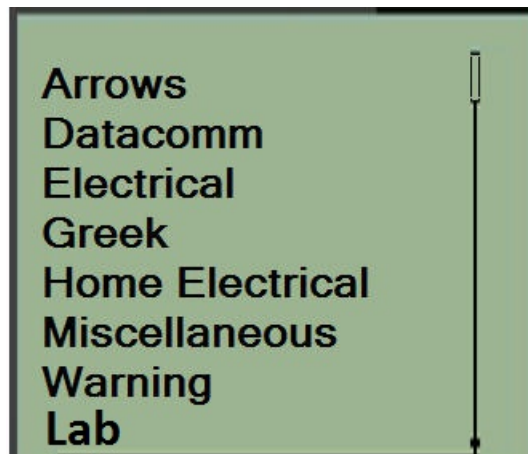

Symbols (graphics) that can be used for a variety of applications are available on the printer. The number of symbols is printer dependent as outlined below:

- M210 = 194 symbols
- M210 with Cyrillic keyboard = 218 symbols
- M210-LAB = 131 symbols

To add a symbol to the label:

1. Position the cursor at the point where you want the symbol to display.
2. Press **SYMBOL**  + .
3. Navigate to the desired symbol category, then press **Enter** .

**Note:** When adding symbols, the printer always returns to the last symbol category used.

4. Using navigation keys, select the desired symbol, then press **Enter**.

You can also choose symbols through the Menu function.

1. Press **MENU**.
2. Navigate to Symbols, then press **Enter** .
3. Navigate to the desired symbol category, then press **Enter**.
4. Using navigation keys, select the desired symbol, then press **Enter**.

The symbol displays with the same font size that is currently in use.

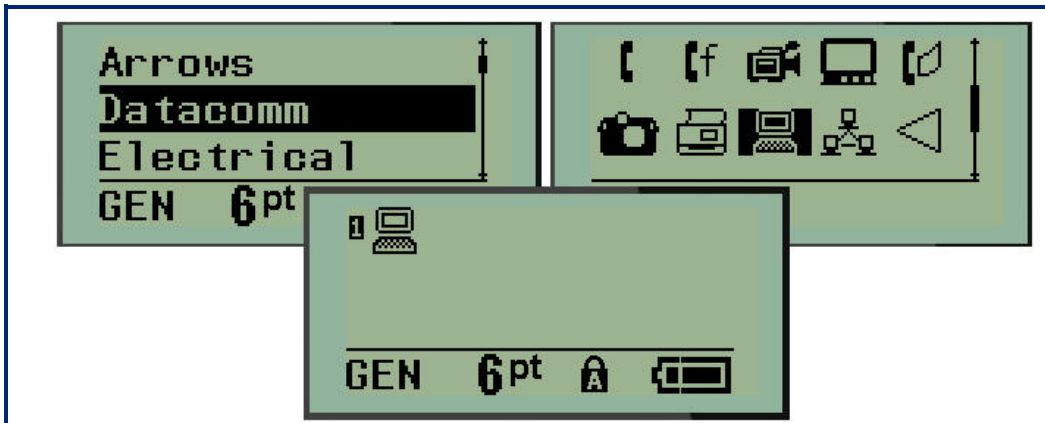

### ***Remove a Symbol***

The symbol is the same as any other character. To remove a symbol:

1. Position the cursor to the right of the symbol.
2. Press **Backspace** .

## International Character Set

The International Character Set supplies characters specific to some international alphabets with diacritical and accent marks incorporated into the characters. To add a character from the International Character Set:

1. Position the cursor where you want the international character to display.

Press **International** key  + **6**  .

OR

Press **MENU** .

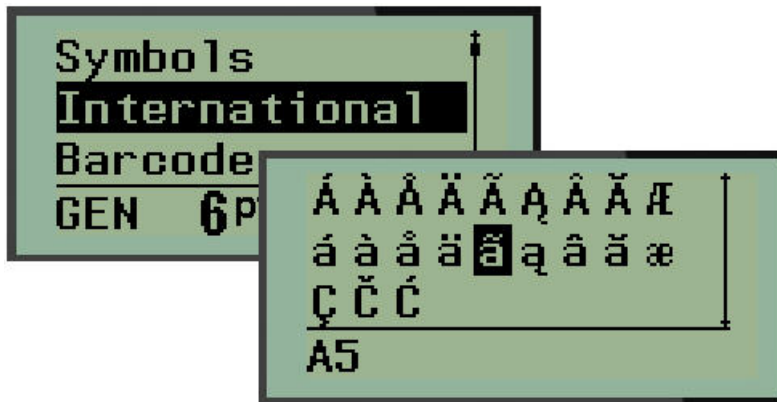

Navigate to **International**, then press **Enter** 

2. Navigate to the desired international character, then press **Enter**.



## Date and Time

To have the current date and/or time inserted on a label:

1. Position the cursor on the label where you want the date and/or time to be inserted.
2. Press **ADD DATE**  +  to display the date.

OR

3. Press **ADD TIME**  +  to display the time.

The printer inserts the Date or Time using the current system clock value at the time of printing and the date/time format defined in the Menu function. (For more information, see “Set Clock” settings on [page 23](#).)

## Timestamp

You can also use the Timestamp menu option to insert the date or time on your label. To Timestamp your label:

1. Place the cursor at the position on the label where you want to stamp the date or time.
2. Press **MENU**.
3. Navigate to **Timestamp**, then press **Enter** .
4. Navigate to **Insert Time** or **Insert Date**, then press **Enter**.

## Barcode

The printer supports Code 39 and Code 128 barcode symbology. You can use either Banner Landscape or Flag label type to insert a barcode. (See [page 50](#) for information on changing the Label Type.)



Barcode data can be displayed in the same line as other data (text or symbols). Barcode data on the same line as text will not overwrite the text already on the line but will be placed next to it.

**Note:** You cannot change the characteristics of the barcode except the font size. The human readable text is placed below the barcode and cannot be removed. The size of the barcode changes with the font size of the human readable text.

### Add a Barcode

Barcode creation is only available for select ASCII characters, as shown in [Appendix B on page 80](#).

To add a barcode:

1. Position the cursor where you want to add the barcode.
2. Press **Barcode**  + **2** .
3. Choose the barcode symbology (39 or 128) and press **Enter** .
4. Enter the barcode data.

**Note:** To change the font size, press **FONT SIZE**, select desired size, press **Enter**.

The barcode displays on the screen as a rectangle around the barcode data. To exit out of the barcode data:

5. Press the right navigation key to move off the barcode.

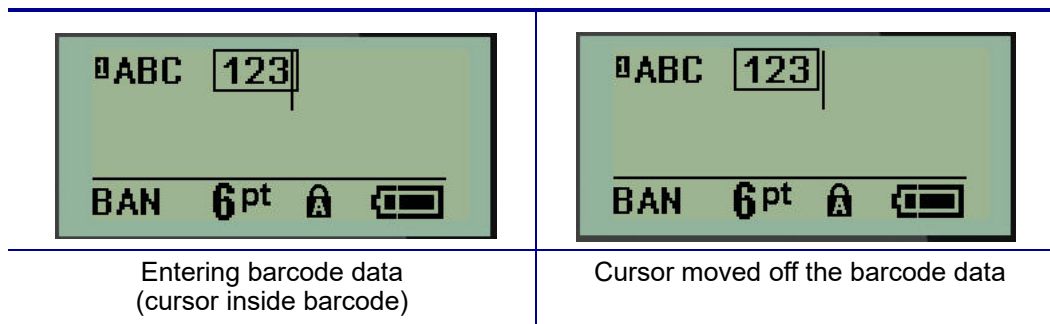

If you want to enter more data on the same line of text as the barcode:

1. Press the right navigation key to move off the barcode.
2. Enter the data. (Be sure to press Space before entering more data if you want to separate the data from the barcode.)

Barcode in line of data	Printed label of barcode in line of data

### Edit Barcode Data

To edit barcode data:

1. Using the left or right navigation keys, position the cursor in the barcode text.
2. If you are deleting barcode data, be sure to position the cursor to the right of the character you want to delete, then press **Backspace** .
3. If you are inserting additional data, position the cursor in the barcode data where new data will be entered, then enter the data.
4. To exit the barcode data, use the left or right navigation keys to move off the barcode data.

### Datamatrix and QR Codes

**Barcode creation is only available for select ASCII characters, as shown in Appendix B on page 80.**

The M210/M210-LAB Label Printer supports Datamatrix and QR Codes in two different sizes, with 0.59 inches (15 mm) being the minimum supported diameter that a Brady scanner can read. Datamatrix Codes will accept a maximum of 44 characters and QR Codes can accept up to 50 characters. This feature is only supported on .75-inch (19.1 mm) media. Multiple lines of text/codes is not supported.





#### Add a Datamatrix or QR Code

**Note:** Label type must be set to Banner Landscape. The size of the codes are preset and not affected by changing font size.

1. Position the cursor where you want to add the code.
2. Press  + .

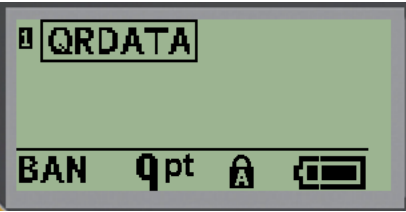

- Use the arrows to scroll to the desired code (Datamatrix or QR) and size (small or large) and press **Enter** .

		
Datamatrix line of data	Small Datamatrix	Large Datamatrix
		
QR line of data	Small QR	Large QR

- Enter data for the code. Use the left and right navigation keys to move within the data which is shown inside a box.
- Press the right navigation key to move off the barcode (outside of the box) and stop adding data to the code.

Editing either type of code is the same steps as editing a barcode as shown on [page 41](#).

## Serialisation

Serialisation (or sequencing) automatically adds a series of sequential numbers or letters to the printed labels. The Serial function consecutively places the next number or letter in the defined sequence on individual labels. The number of labels created is defined by the sequence values you enter.

serialisation can be combined with other data on a label. Any data displayed on a label that includes serialisation will be repeated on every label along with the serial data. You can also incorporate serialised data into a barcode. However, you can only have one serialised data set per label file. (I.e., you cannot put two different serialisation sequences on one label.)

### How Serialisation Works

Serialisation is alphanumeric, with numbers from 0 to 9, and letters A-Z. Serialisation consists of a Start Value, End Value, and Increment. The Start Value is the number or letter that begins the serialisation sequence. (You can use multiple numbers or letters in the sequence. However, you cannot combine numbers and letters in the same sequence.) The End Value is the termination point of the sequence.

The Increment is the value that is added to the previous number in the sequence to produce the next sequence number. (You cannot have an increment value of 0.) For instance, a start value of 1, an end value of 25, and an increment of 4 would produce 1, 5, 9, 13, 17, 21, 25.

**Note:** Letters are sequenced according to their place in the alphabet. For instance, the letter A occurs first in the alphabet (1), B is second (2), C is third (3), and so on. When sequencing letters, the Increment value is still entered as a number.

### Examples of Serialisation

In a simple serialisation, a sequence runs through its full range of numbers and/or letters (i.e., 0 to 9, or A to Z), one number/letter for each label. Starting with the Start Value, the Increment value is added to the previous number to produce the next sequence number, until it reaches the End Value.

**Example:** Simple serialisation 1:

Start Value:	1
Increment:	1
End Value:	10
Produces:	1, 2, 3, 4, 5, 6, 7, 8, 9, 10

Sequencing progresses only until the End Value is reached, it cannot go over the End Value. When the Increment Value is larger than 1, it may produce a sequence that does not print the End Value.

**Example:** Simple serialisation 2:

Start Value:	1
Increment:	2
End Value:	10
Produces:	1, 3, 5, 7, 9

In the above example, the increment value of 2 is added to each previous sequence number. Therefore,  $1 + 2 = 3$ ,  $3 + 2 = 5$ ,  $5 + 2 = 7$ ,  $7 + 2 = 9$ . It cannot add 2 to sequence number 9 because that would produce sequence number 11, which is higher than the end value of 10.

**Note:** The M210 Label Printer can only process simple serialisations, as in the above two examples. It can also process serialisations using single or multiple letters.

### Using Letters in Serialisation

Sequencing letters occurs according to the letter's position in the alphabet. Below is a chart referencing alpha character positions in the English alphabet.

<b>A</b>	<b>B</b>	<b>C</b>	<b>D</b>	<b>E</b>	<b>F</b>	<b>G</b>	<b>H</b>	<b>I</b>	<b>J</b>	<b>K</b>	<b>L</b>	<b>M</b>
<b>1</b>	<b>2</b>	<b>3</b>	<b>4</b>	<b>5</b>	<b>6</b>	<b>7</b>	<b>8</b>	<b>9</b>	<b>10</b>	<b>11</b>	<b>12</b>	<b>13</b>

<b>N</b>	<b>O</b>	<b>P</b>	<b>Q</b>	<b>R</b>	<b>S</b>	<b>T</b>	<b>U</b>	<b>V</b>	<b>W</b>	<b>X</b>	<b>Y</b>	<b>Z</b>
<b>14</b>	<b>15</b>	<b>16</b>	<b>17</b>	<b>18</b>	<b>19</b>	<b>20</b>	<b>21</b>	<b>22</b>	<b>23</b>	<b>24</b>	<b>25</b>	<b>26</b>

**Example:** Letter sequence:

Start Value: A  
 Increment: 3  
 End Value: M  
 Produces: A, D, G, J, M

### Multi-Letter Serialisation

You can serialise up to three letters at a time. When the right-most character in the Start Value reaches its maximum value (Z), the character immediately to the left is incremented, and the right character cycles back to its minimum value (A). It is important to understand how letter serialisation works as it can produce a very large amount of labels.

**Example:** Multiple Letter Serialisation 1:

Start Value: AB  
 Increment: 1  
 End Value: BB  
 Produces: AB, AC, AD, AE.....AZ, BA, BB

In the above example, 27 sequences are produced. Starting with AB, the right-most character runs the entire alphabet until it reaches its maximum value (Z). When the end of the alphabet is reached, the character immediately to the left increments one letter and the sequence starts again. This process continues up to the End Value of BB.

## Add Serialisation

To add serialisation to labels:

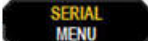
1. Position the cursor on the label where you want the serialisation to display.
2. Press **SERIAL**  + **SERIAL MENU** .

A dialog box displays where you can enter the start value of the serialisation, the increment value, and the end value.



For simple serialisation:

3. With the cursor immediately displayed in the *Start:* field, enter the start value of the sequence.
4. In the *Increment* field, enter the increment value.
5. In the *End:* field, enter the end value of the sequence.

The default increment is 1. If that is the desired increment, skip this entry field.

6. To process the serialisation, press **Enter** .

## Edit a Sequence

You can change the serialisation values after a sequence has been determined. To edit the sequence values, from anywhere on the label (the cursor does not have to be in the serialised data set):

1. Press **SERIAL**  + **SERIAL MENU** .

The Serial dialog box displays with the current values listed.

2. Navigate to the value fields to change and enter the new value.
3. When finished, press **Enter** .

## 4 File Management

---

A label can be saved as a file, to be opened and reused at a later date. You can save up to 12 files. The files are retained and are not lost when removing the batteries.

**Note:** The M210/M210-LAB printer CANNOT be connected to a PC, therefore you cannot print PC label files on the printer.

### File Naming Standards

To create a file the file must be given a name. Names can be up to 11 characters long and can consist of letters, numbers, and spaces.

Unlike file names in a Windows environment, two different files can have the same name. File names in the M210 Label Printer are designated and separated by the position number (1 - 12) so same names are allowed.

### Save a File

You can save a file internally on the M210. The saved file retains the label data and data attributes. This file is available for reuse whenever needed.

To save labels as a file:

1. Press **MENU**.
2. Navigate to File, then press **Enter** .
3. Navigate to Save, then press **Enter**.
4. Navigate to an open numbered field (blank field) and press **Enter**.

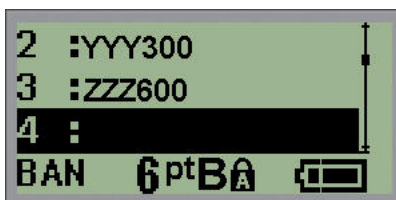

5. In the *File Name?* field, enter a name for the file, then press **Enter**.



When the file is saved, you are returned to the Editing screen with the saved file still displayed.

To remove the saved file from the screen:

6. Press **CLEAR**  + .

## Replace (Overwrite) a File

You can only save 12 files on the printer. To save another file, you need to replace (overwrite) one of the previously saved files. To replace, or overwrite, a file:

1. Press **MENU**.
2. Navigate to File, then press **Enter** .
3. Navigate to Save, then press **Enter**.
4. Navigate to the numbered field containing the file you want to overwrite and press **Enter**.

A message displays requesting confirmation on replacing the previous file.



To overwrite the previous file:

5. Navigate to **Yes**, then press **Enter**.
6. In the *File Name?* field, enter a name for the file, then press **Enter**.

## Open a File

To open (recall) a saved file:

1. Press **MENU**.
2. Navigate to File, then press **Enter** .
3. Navigate to Open, then press **Enter**.

A list of previously saved files displays.

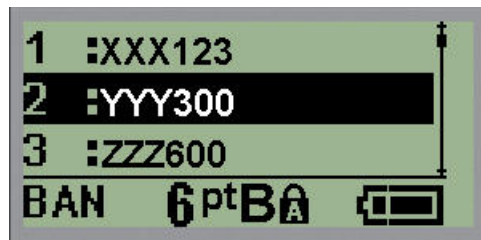

4. Navigate to the file to open, then press **Enter**.

Only one file can be displayed on the screen at a time. When opening a saved file, if the Editing screen contains data, the opened file overwrites that data. If the previous data on the screen was not saved, that data is lost.

## Delete a File

The display screen does not have to be cleared before deleting a file. A file can be deleted with other data still on the screen.

To delete a previously saved file:

1. Press **MENU**.
2. Navigate to File, then press **Enter** .
3. Navigate to Delete, then press **Enter**.

A list of previously saved files displays.

4. Navigate to the file to delete, then press **Enter**.

A delete confirmation message displays.



5. Navigate to **Yes**, then press **Enter**.

**Note:** If you enter 'No', you will be returned to the list of saved files. You can select another file to delete OR press [BACKSPACE]  to move out of the File>Delete menus and return to the Editing screen.

When a file is deleted, it is removed from the system and is no longer available for use.



# 5 Label Types

Label types provide templates that guide and control the layout for label formats and may require specific media.

The label types available are:

M210 and M210-Russian Label Printer	The M210-LAB Label Printer
<ul style="list-style-type: none"> <li>• Banner Portrait</li> <li>• Banner Landscape</li> <li>• Fixed Length</li> <li>• Custom Length</li> <li>• Vial</li> <li>• WireMarker</li> <li>• Terminal Block</li> <li>• Patch Panel</li> <li>• Panel-Residential</li> <li>• Flag</li> <li>• Breaker Box</li> </ul>	<p>The printer is intended for laboratory environments and therefore contains only the following label types.</p> <ul style="list-style-type: none"> <li>• Banner Portrait</li> <li>• Banner Landscape</li> <li>• Custom Length</li> <li>• Fixed Length</li> <li>• Vial</li> </ul>

## Selecting a Label Type

To select a label type:

1. Press **LABEL TYPE**.
2. Using navigation keys, choose the desired Label Type, then press **Enter** .

**Note:** If the correct media is not installed in the printer, some of the label type templates will not display in the Label Type menu. For example, if a permasleeve cartridge is loaded, the wiremarker template will not be available.

For some label types, data fields display to collect information for automatically formatting the specific label type.

3. Navigate to the different data fields and enter the data requested.
4. When finished, press **Enter**.

## Banner Portrait Label Type

Banner Portrait label type is used for creating basic labels, with no specific formatting. Banner portrait supports all media except SelfLam and Permasleeve.

When you are using a specific label type, clearing the data removes the data you entered but the specific label type parameters remain. To exit out of the specific label type and return to the general editing mode of the M210/M210-LAB Label Printer, select the Banner Portrait label type.

1. Press **LABEL TYPE**.
2. Using navigation keys, choose **Banner Portrait**, then press **Enter** .
3. Using navigation keys, choose Horizontal or Vertical text, then press **Enter**.

**Note:** When using Horizontal Text on a Banner Portrait label type, you are limited to four lines of text and the message “Cannot Fit” displays if each individual line of text is too long. When using Vertical Text on a Banner Portrait label, you are limited to four lines of text with each individual line having a maximum of 50 characters per line. Vertical text is the only option available for use with pre-sized labels.

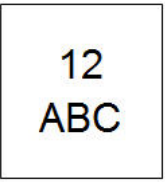
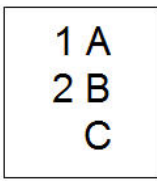
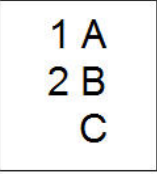
	
<p>Banner Portrait label type horizontal text on screen</p>	<p>Banner Portrait label type horizontal text printed out</p>
	
<p>Banner Portrait label type vertical text on screen (limited to four lines)</p>	<p>Banner Portrait label type vertical text printed out</p>

The parameters of the previous label type in use are removed from the screen and you are returned to the general editing mode.

## Banner Landscape Label Type



Banner Landscape label type allows you to enter a long text string. Any media can be installed for Banner Landscape. If a label type is not supported for newly installed media, the label type automatically switches to Banner Landscape.

To print a long text string (i.e., producing a “banner”):

1. Press **LABEL TYPE**.
2. Using navigation keys, choose **Banner Landscape**, then press **Enter** .
3. Using navigation keys, choose Horizontal Text or Vertical Text, then press **Enter**.

**Note:** When using Vertical Text on a Banner Landscape label type, you are limited to four lines of text and the message “Cannot Fit” displays if each individual line of text is too long. When using Horizontal Text on a Banner Landscape label, you are limited to four lines of text with each individual line having a maximum of 50 characters per line. Horizontal text is the only option available for use with pre-sized labels.

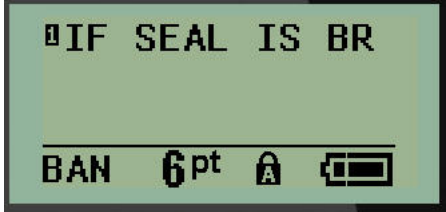
4. On the Editing screen, enter the text string.

	
<p>Banner Landscape label type - text on screen</p>	<p>Banner Landscape label type - text printed out</p>

## Fixed Length

If the label type is set to Banner landscape the label length will be as long as necessary to accommodate the font size and text entered. However, you can set the length of the media to a fixed length, which may restrict how much data you can enter on the label.

**Note:** On all labels, there exists a fixed margin that measures the distance between the edge of the print head and the cutter blade. This distance cannot be changed.

To set a fixed label length:

1. Press **LABEL TYPE**.
2. Navigate to **Fixed Length**, and press **Enter** .
3. Navigate to the desired length, and press **Enter**.

Enter data as usual. If you enter more data than the fixed length label can accommodate, the error message “Cannot Fit” displays and you are returned to the label.



To correct the error, you can delete text (see [page 33](#)), change the font size (see [page 34](#)), or select a larger fixed length label size by performing the above three steps.

## Custom Length

Setting a custom length gives you the option to set smaller label lengths than what is available with the fixed length setting. The maximum length is 99.9 inches (2537.46mm) with the maximum number of characters at 50. Text will be centered on the label, regardless of length.

To set a custom label length:

1. Press **LABEL TYPE**.
2. Navigate to **Custom Length**, and press **Enter** .
3. Use the number keys to enter the desired length, and press **Enter**.

Enter data as usual. If you enter more data than the fixed length label can accommodate, the error message “Cannot Fit” displays and you are returned to the label.



To correct the error, you can delete text (see [page 33](#)), change the font size (see [page 34](#)), or select a longer custom length label size.

## Vial

The Vial label type can be used with any media except SelfLam or Permasleeve. (If SelfLam or Permasleeve media is installed, the Vial label type does not display.) The Vial label type fixes the length of the label based on the vial size selected and formats the data horizontally or vertically. To get the most data in a small area it is recommended to use a 2D barcode.

To create a label using the Vial label type:

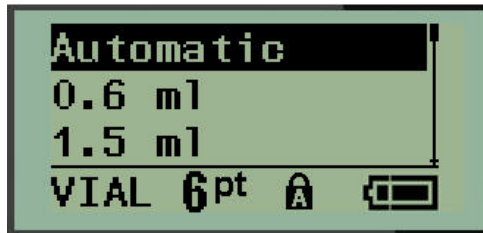

1. Press **LABEL TYPE**.
2. Navigate to **Vial**, then press **Enter** .



3. Navigate to the desired vial size, then press **Enter**.

**Note:** Width is automatically determined when using pre-sized labels.

4. Select the way you want the data to print on the label - landscape (horizontal) or portrait (vertical), then press **Enter**.

	
Landscape (horizontal on printed label)	Portrait (vertical on printed label)

5. Enter the data to display on the vial label.

## WireMarker Label Type (M210)

The WireMarker label type is designed to repeat entered data down the length of the label. The data repeats as many times as possible, considering the font size and the wire size selected.

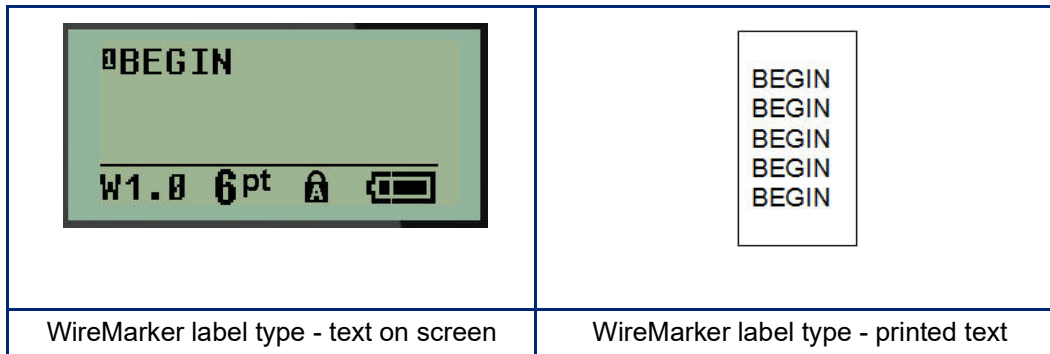

All media, except Permasleeve, support WireMarker label types.

To use the WireMarker label type:

1. Press **LABEL TYPE**.
2. Using navigation keys, choose **WireMarker**, then press **Enter** .
3. Navigate to the appropriate label size to fit the intended wire, then press **Enter**.

**Note:** Size is automatically determined when using pre-sized labels and is displayed in the lower left corner of the screen (examples: W.75, W1.5, W2.0)

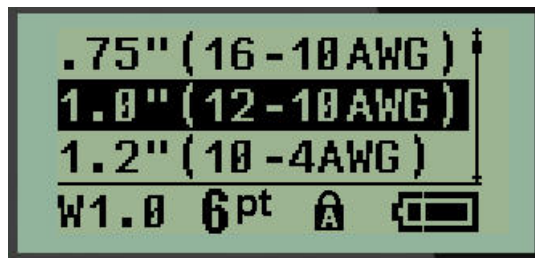

4. Enter the data you want repeated down the length of the label.

**Note:** The repeated data does not display on the screen, but displays on printout.

5. Press **Enter** to start a new line of text.

When the label is printed, both lines of text are repeated down the label, depending on the size of the label and font.

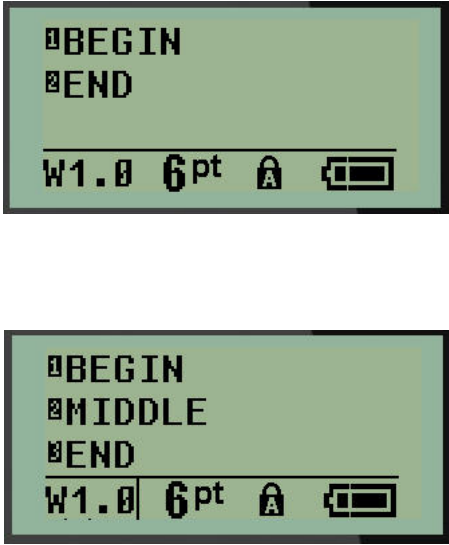
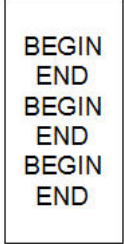
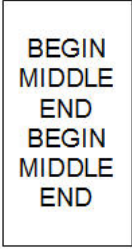
	 
<p>WireMarker label type - multiple lines as displayed on screen</p>	<p>WireMarker label type - multiple lines as displayed on print out</p>





## Terminal Block, Patch Panel (M210)

Terminal Block and Patch Panel label types are designed to be used with any media, except SelfLam or Permasleeve. If SelfLam or Permasleeve is installed, these label types are not available.

To use Terminal Block or Patch Panel:

1. Press **LABEL TYPE**.
2. Navigate to the desired label type and press **Enter** .

Data fields display requesting additional information. (For a review of data field navigation, see [page 21](#).) The data fields for Terminal Block and Patch Panel are similar.

	
Terminal Block data fields	Patch Panel data fields

3. In the *Spacing:* field, choose a pre-programmed value using the left or right navigation key or, when the cursor is flashing, enter your own value\* for the amount of space that exists between the terminals or ports.

\*If a custom value was previously entered, it will remain in the printer.

**Note:** If you have indicated the correct spacing between the requested number of terminals or ports, the printed label can be attached to the terminal block or patch panel as one strip. There is no need to cut and adhere each individual block or port identifier.

4. Navigate to the *Serial:* field, then use the left or right navigation key to turn serialisation ON or OFF.

If serialisation is turned ON, proceed to Step 6.

**Note:** If serialisation is turned ON, you do not have to specify the number of terminations (or the number of ports if using Patch Panel).

If serialisation is turned OFF, continue with the

5. ~~Navigation:~~ Navigate to the *# of Terminations:* (or *# of Ports:*) field and enter the number of terminals or ports needed.
6. Navigate to the *Rotation:* field (not visible on the initial data fields screen), and determine if you want the label data to print out at 0° rotation (landscape) or print vertically at 90° rotation (portrait). Use the left or right navigation key to switch between degrees of rotation.

<div style="border: 1px solid black; padding: 5px; display: inline-block;">A1 A2 A3 A4</div>	<div style="border: 1px solid black; padding: 5px; display: inline-block;">A1 A2 A3 A4</div>
Landscape printout - rotation 0°	Portrait printout - rotation 90°

7. When finished, press **Enter**.

**Note:** If serialisation was turned OFF, proceed to Step 15. If serialisation was turned ON, you are presented with the Serial screen. Continue with the following:



8. With the cursor displayed in the *Start*: field, enter the start value of the sequence.

9. In the *Increment* field, enter the increment value.

The default increment is 1. If that is the desired increment, skip this entry field.

10. In the *End*: field, enter the end value of the sequence.

11. When ready, press **Enter**.

**Note:** If serialisation was turned ON, the serial start value is displayed on the editing screen. However, all labels in the serial sequence will print out. Likewise, if you delete the start value on the editing screen, the entire serialisation sequence will be deleted.

To delete the serialisation sequence:

12. Press **Backspace** .

A confirmation message displays.





To delete the entire sequence:

13. Press **Enter**.

To cancel the deletion:

14. Press **Backspace**  again.

**Note:** If serialisation was turned OFF, the number of terminals (or ports) display in individual areas. The terminal areas display in the upper right corner of the editing screen.

	
<p>Terminal Block editing screen Serialisation turned OFF</p>	<p>Patch Panel editing screen Serialisation turned OFF</p>

15. Use the up and down navigation keys to navigate to the first numbered data field and enter the identifying information for that terminal.
16. When on a terminal number, use the left or right navigation key to toggle to another terminal number.

## Panel Residential (M210)

Allows you to create labels for residential breaker box panel/door using pre-defined or user-defined terms. Labels print portrait if more than one line is used.

For the best fit on a standard residential breaker box use font size 9 on 0.25 inch (6.35mm) width media. All labels are printed left justified with the same fixed width and accept up to 15 characters maximum.

Available labels (listed in order of appearance):

A/C	Bedroom 4	Kitchen
Alarm	Den	Dish Washer
Basement	Dining Room	Microwave
Bathroom 1	Family Room	Refrigerator
Bathroom 2	Office	Stove
Bathroom 3	Living Room	Garage
Master Bedroom	Utility Room	Exterior
Bedroom 1	Laundry	Furnace
Bedroom 2	Dryer	Water Heater
Bedroom 3	Washer	Smoke Detector

1. Press **LABEL TYPE**.
2. Using navigation keys, choose **Panel Residential**, then press **Enter** .
3. Use the right/left navigation keys to toggle between Yes or No to select **YES** to print all 30 panel labels or **NO** to choose specific labels.
4. (Optional) Use the number keys to change the number of copies or the navigation pad to increase/decrease the number.

**Note:** When multiple copies are chosen the labels will collate as they print.

- (Optional) Navigate to **Cut Between**, use the right or left navigation key to toggle between YES or NO, then press **Enter**.



Choosing “YES” on Cut Between will prompt you to “Cut” or “Press Print” after each label during printing.

**Note:** Even if the printer is already set to cut between mode, it still needs to be selected here.

**Note:** It is not possible to return to the set-up menu after leaving it. To exit the application from the

set-up menu, press .



- Select all desired labels using the right/left navigation keys to toggle between Yes or No, then press **Enter**.  
A preview of the first panel label will display.
- (Optional) To change the text of the label press the down navigation key.
- Use the **Backspace**  to erase the characters and the keypad to enter up to 15 characters of text.
- Press the up navigation key to return to the panel number in the upper right corner followed by the right navigation key to move to the next label, the left key for the previous label or use the keypad to enter the number of the panel, followed by **Enter** to go to a specific panel.
- After the last label has been previewed/changed, press **Enter** to add additional labels or **Backspace**  to return to the last panel.
- Press **PRINT**.

Exit Panel Residential without creating labels by pressing the **Backspace**  twice. The options you already selected will be available the next time you enter the feature.

## Flags (M210)

A Flag label wraps around a wire or cable, with the ends joined together to form a flag. The Flag label type is designed to work with any media except SelfLam or Permasleeve.

To use a Flag label type:

1. Press **LABEL TYPE**.
2. Navigate to **Flag** and press **Enter** .

Data fields display requesting additional information.

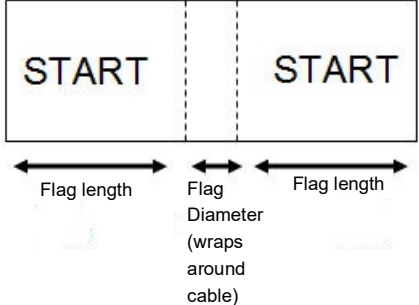
	
Flag data fields	Flag label on print out

3. In the *Flag Length*: field, enter the total length of the flag (as it exists before being wrapped around a wire or cable).

**Note:** Length is automatically determined when using pre-sized labels.

4. In the *Cable Diameter*: field, enter the diameter measurement of the cable to which the flag will be applied.

**Note:** Maximum cable diameter is automatically determined when using pre-sized labels.

The cable diameter is a minimum of 0.01 inch (.254 mm), a default of 0.25 inches (6.35 mm) and a maximum of 9.99 inches (253.7 mm). By entering the diameter of the wire or cable, the system automatically calculates an additional length of label to allow complete wrap of the wire/cable with additional label material left for the flag.

- In the *Style:* field, use the left or right navigation key to display the eight different flag rotations.

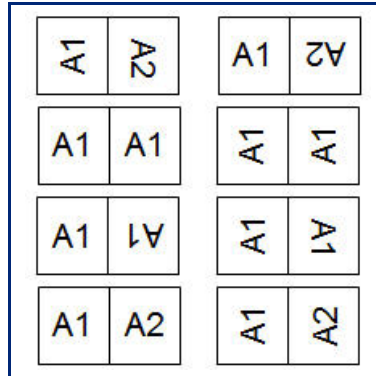

- When finished, press **Enter**.

Rotation is embedded in the template design, based on the flag design you pick. Justification defaults to center, middle. The font size remains whatever size is set when the flag label type is chosen.

If the design chosen indicates only one text element, the printer automatically duplicates the entered text for the other area, rotating according to the predefined layout.

In a 2-text element flag layout, you enter text in two separate areas. The areas are designated at the top of the screen.

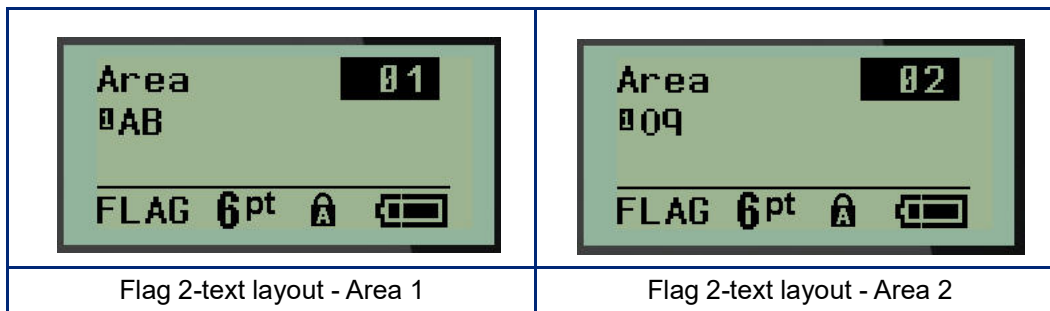

To move to the different areas:

- Using the up/down navigation keys, navigate from the line number to the area number listed on the top right of the editing screen.
- On the area number, use the left/right navigation keys to toggle between Area 01 and Area 02.
- When on the desired area, use the down navigation key to move to the line number in that area and enter the text to display in that area of the flag.

## Breaker Box (M210)

Breakers are usually arranged in two columns or along one row, depending on geographic regions. The breaker positions are numbered left-to-right or top-to-bottom, depending on label orientation. This numbering system is universal across various competing manufacturers of breaker panels.

To create Breaker Box labels:

1. Press **LABEL TYPE**.
2. Navigate to **Breaker Box**, then press **Enter** .



3. In the *Spacing*: field, enter the width of a standard breaker.
4. In the *# of Breakers*: field, enter the number of breakers to be labeled. This produces one continuous strip, vertically aligned for US breaker boxes, or horizontally aligned for EU breaker boxes.

A "partition" is a separator line that prints between breakers on a label. Indicate if you want a separator line to print.

5. In the *Partition*: field, use the left or right navigation keys to turn the partition on or off.
6. In the *Rotation*: field (not visible on the initial data fields screen), use the left or right navigation keys to access the degree of rotation desired for the printed labels - landscape (0°) or portrait (90°).

<div style="border: 1px solid black; padding: 5px; display: inline-block;">A1 A2 A3 A4</div>	<div style="border: 1px solid black; padding: 5px; display: inline-block;">A1 A2 A3 A4</div>
Landscape - 0° rotation	Portrait - 90° rotation

7. When finished, press **Enter**.



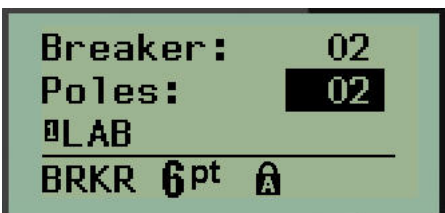

On the Breaker Box editing screen, enter the number of poles for each breaker and the corresponding identifying data. The number of the breaker displays in the upper right corner of the editing screen.

8. Using the up and down navigation keys, navigate to the breaker number.
9. When on the breaker number, use the left or right navigation keys to toggle to another breaker number.

	
Breaker field accessed	Pole field accessed

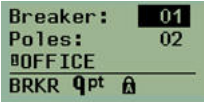
10. Navigate to the Poles: number (directly under the breaker number) and enter the number of poles for that breaker. (You can also use the navigation keys to toggle to different numbers.)
11. Navigate to the first numbered data field and enter the identifying information for that breaker.
12. Repeat Steps 7 through 10 for each breaker.

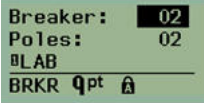
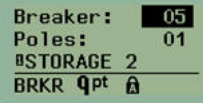
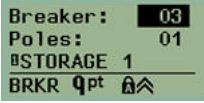
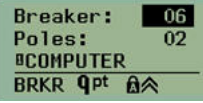
		<table border="1"> <tr> <td style="text-align: center;">OFFICE</td> <td style="text-align: center;">LAB</td> <td style="text-align: center;">STORAGE 1</td> <td style="text-align: center;">RECEPTION</td> <td style="text-align: center;">STORAGE 2</td> <td style="text-align: center;">COMPUTER</td> </tr> </table>	OFFICE	LAB	STORAGE 1	RECEPTION	STORAGE 2	COMPUTER
OFFICE	LAB		STORAGE 1	RECEPTION	STORAGE 2	COMPUTER		
								
								
Breaker box editing screens (6 breakers, 1 and 2 poles)		Printout of breaker box, with partition turned on (notice space between breakers based on number of poles)						



## 6 Troubleshooting

Use the following table to troubleshoot and diagnose possible performance problems with your M210/M210-LAB Label Printer. If the corrective action suggested does not work, contact Brady's Technical Support Group (see [page 67](#)).

Problem	Cause	Corrective Action
Hardware		
Keyboard works intermittently or not at all.	One or more keys is stuck in depressed state.	Identify any keys stuck in down position. Repress key to un-stick.
Cutter does not cut	Label slivers in cutter assembly	<p>Use a small tool such as tweezers or needle-nose pliers to carefully remove the media slivers from the cutter assembly. Use caution not to damage any of the components in the cutter assembly while removing media slivers. If you have concerns, please contact technical support for further assistance.</p> <div style="text-align: center;">  <span style="font-size: 1.2em; font-weight: bold; color: red;">WARNING</span> </div> <p>Never attempt to remove slivers with your fingers. The cutter assembly includes very sharp components that can cause injury.</p>

Problem	Cause	Corrective Action
<p>Printer jammed, cannot feed labels</p>	<p>Label exit chute is blocked causing label material to back up inside printer</p>	<p>To clear the jam inside the printer:</p> <ul style="list-style-type: none"> <li>• Slide the locking lever to the unlock position.</li> </ul> <p><b>Note:</b> Unlocking retracts the platen so the cartridge can be removed. If there is a large jam, you may have to force the locking lever to the unlock position.)</p> <ul style="list-style-type: none"> <li>• Remove the cartridge.</li> <li>• Use tweezers or a needle-nose pliers to clear label jam.</li> </ul> <div style="text-align: center;">  <p><b>WARNING</b></p> </div> <p>The print head is susceptible to damage. Using metal objects to remove jams can scratch, dent, or crack the print head. Use every precaution when clearing a jam.</p>

Problem	Cause	Corrective Action
Power ON/OFF - Printer not working		
Printer does not power up when turned on.	Battery pack is not charged.	<p>If using batteries, replace with 6 new AA batteries.</p> <p>OR, if using the lithium ion battery, remove the battery from the printer and recharge using the AC adapter.</p> <p>To use the printer while charging the lithium ion battery, insert 6 AA alkaline batteries in the battery compartment.</p>
Screen freezes	User interface error.	<ul style="list-style-type: none"> <li>• Press Power button to turn the printer off.</li> <li>If Power button does not shut down printer:</li> <li>• Remove the AC adapter (if using one).</li> <li>• Remove the battery pack, or batteries, then immediately re-insert.</li> <li>• Power ON the printer.</li> </ul>
LCD reads "Error"	Battery is low. Not using correct media. Motor not working.	<p>If using batteries, replace with 6 new AA batteries.</p> <p>OR, if using the lithium ion battery, remove the battery from the printer and recharge using the AC adapter.</p> <p>Insert correct media cartridge.</p> <p>If new batteries and the installing the correct media cartridge does not clear the error message, send the printer in for repair.</p>
LCD reverts to previous label text.	Battery is low.	<p>If using batteries, replace with 6 new AA batteries.</p> <p>OR, if using the lithium ion battery, remove the battery from the printer and recharge using the AC adapter.</p>





Problem	Cause	Corrective Action
Printer frequently powers OFF.	Battery is low.	<p>Note: The printer is programmed to shut off automatically after 10 minutes of inactivity.</p> <p>Install 6 fresh AA batteries.</p> <p>OR</p> <p>Attach the AC Adapter to the printer and plug into an electrical outlet. This will supply immediate power.</p> <p>If using the lithium ion battery, remove the battery from the printer and recharge using the AC adapter.</p> <p>To use the printer while the lithium ion battery is being recharged on the AC adapter, insert 6 AA alkaline batteries in the battery compartment, or purchase a second AC adapter to power the printer while the battery is charging.</p>
Printer not responding	Battery is dead.	<p>If using the lithium ion battery, remove the battery from the printer and recharge on the AC adapter.</p> <p>To use the printer while the lithium ion battery is recharging, install 6 new AA batteries in the battery compartment.</p>
Error - "Cut while printing"	Operating cutter while labels are still printing.	<ul style="list-style-type: none"> <li>• Cut through the material completely.</li> <li>• Press Clear  +  key to clear error.</li> <li>• Reprint the label(s).</li> </ul>
Printing from PC	The M210/M210-LAB printer CANNOT be connected to a PC, therefore you cannot print PC label files on the printer.	To obtain a Brady printer that can be connected to a PC, contact Brady customer service at 888-250-3082.

Problem	Cause	Corrective Action
Print Quality		
Poor print quality	Battery pack, or 6 AA batteries, may be worn out and not properly holding a charge.	Battery life is approximately one to three years, depending on its use and care. Order a replacement battery pack or insert 6 new AA batteries.
Poor print quality.	Dust or adhesives accumulated on the print head.	Clean the print head. (Refer to <a href="#">page 75</a> for instructions on cleaning the printer.)
Poor print quality	Media not usable.	Try another media cartridge.
Void areas or lines appear on printed text.	A creased line occurs on the label. When printing over the crease, the ribbon ink cannot fill in the indenture.	<ul style="list-style-type: none"> <li>• Advance the label material to jump over the crease.</li> <li>• Reprint your label.</li> </ul>
Void areas or lines appear on printed text.	Ribbon wrinkling.	<ul style="list-style-type: none"> <li>• Remove the cartridge from the printer and advance the ribbon by rotating the take-up spool clockwise until the wrinkled/damaged ribbon is no longer visible (typically about one or two full turns).</li> <li>• Reinstall the cartridge and continue printing normally.</li> </ul> <p>OR, try a new cartridge.</p>
Black line displays on first label printed.	When the cartridge is left in the locked position (when not in use), the print head is pressed against the platen roller, causing a vertical pressure point line (or residual burn line) to appear on the tape.	Unlock the cartridge as soon as you are done printing more labels. This will prevent the warm print head from burning the ink from the ribbon onto the next label under the print head.



Rotate spool clockwise to advance ribbon

Problem	Cause	Corrective Action
Labels		
Printer will not feed labels.	The leading edge of the label roll is uneven or torn (not a straight edge). Locking lever not engaged.	Use a pair of scissors to cut a straight leading edge on the label roll. Verify the locking lever is in the correct position.
Press Print but nothing feeds out	Locking lever not engaged. Damaged label cartridge. Exit chute jammed.	Verify the locking lever is in the correct position. Insert a different label cartridge. Verify exit chute is not blocked
Compressed print, poor registration	Dirty platen roller	Make sure the last cut label has been removed from the label tray. Clean the platen roller. (See <a href="#">page 75</a> for cleaning information.)
Error - "No / Invalid Cartridge"	No cartridge or non-Brady brand cartridge installed. Damaged circuit board on label/media roll.	Verify that Brady media cartridge installed. <ul style="list-style-type: none"> <li>• Replace label/media roll.</li> <li>• Press [CLEAR/ESC] key to clear error</li> </ul>
Error - "Insert labels"	Damaged contacts in receiver slot of lower printer base.	Contact Technical Support.
Printing a symbol produces the "Cannot Fit" message.	Some symbols cannot print at 6 pt font.	Change the font size to 9 pt or larger.
Error - "Check Cartridge / Lever"	Locking lever not engaged. Cartridge is empty. Label is jammed.	Verify the locking lever is in the correct position. Insert new cartridge. Remove cartridge, cut off damaged portion, reinsert cartridge.

Problem	Cause	Corrective Action
Program		
Invalid terminal repeat value entered.	The value entered is out of the range.	The acceptable range is between the minimum of 0.2 inch (50.8mm) to the maximum of 40 inches (1016mm).
Error - "Cannot Fit"	Font size and settings too large for label.	<ul style="list-style-type: none"> <li>• Change the font size to a smaller font. (See <a href="#">page 34.</a>)</li> <li>• Delete some text. (See <a href="#">page 33.</a>)</li> </ul>
Error - "Cannot Fit"	There are too many lines of text. The maximum number of lines allowed is four, but may be less when using pre-sized labels.	A blank line is considered another line of text. DO NOT press ENTER at the end of a line if you DO NOT want another line. (See <a href="#">page 32.</a> )
Error - "Cannot Fit"	Wrong label type or orientation	<ul style="list-style-type: none"> <li>• Select a different label type (e.g., banner landscape). (See <a href="#">page 50.</a>)</li> <li>• Change orientation (vertical or horizontal). (See <a href="#">page 51.</a>)</li> </ul>
"Cannot Fit" message received while typing.	No more room on the label using the font currently in use.	<ul style="list-style-type: none"> <li>• Check the label type. Sometimes wiremarker or fixed length is accidentally selected rather than banner.</li> <li>• Check that an additional line of text was not inadvertently added.</li> </ul>
Left and right justification not working.	The printer currently does not support left or right justification. All label text will be center justified only.	No action required.
Text not centered on label.	Possible blank spaces added to text.	Press Clear  +  , then re-enter text.
A large section of blank label prints after text.	Possible blank lines added after text.	Press Clear  +  , then re-enter text.
Cannot change location of the human readable text in a barcode.	The human readable text is automatically added below the label. This position is fixed and cannot be changed.	No action required.
Cannot add checksum character in barcode.	The printer does not allow checksum characters to be used.	No action required.



Problem	Cause	Corrective Action
Menu does not display all label types.	The M210/M210-LAB only displays the label types that will work with the installed label material (cartridge). Fewer label types are supported when using pre-sized cartridges.	Insert the proper label material (cartridge) for the labels you want to produce. Examples: <ul style="list-style-type: none"> <li>• If using Nylon, Vinyl or Polyester continuous labels, all labels types will be shown.</li> <li>• If using Self-Lam labels the only label types displayed are Banner Landscape, Fixed Length and Wire.</li> <li>• If using Permasleeve labels, the only label types that will be shown are Banner Landscape and Fixed Length.</li> <li>• Only .75-inch media will work with 2D barcodes.</li> </ul>
Cannot change to a different language.	Pressed a wrong key while in language setup.	Reset the language. See <a href="#">page 22</a> for information on setting a specific language.
Datamatrix and/or QR code can't be entered.	Label type is set to Banner Portrait.	Set label type to Banner Landscape.
Unable to exit screen or feature.	Pressing the CLEAR key only erases data on the screen.	Press the CLEAR key twice to exit from a feature or screen.
Text on pre-sized labels is not positioned correctly.	Sensor is blocked by debris.	Remove the cartridge and blow debris off of the sensor using a can of compressed air or a lint-free swab. See <a href="#">page 75</a> .

## Cleaning the Printer

Cleaning the printer will improve print quality and legibility. It also increases output, machine life, printer reliability and performance.

### Display Screen

1. Lightly moisten a soft (non-scratching) cloth with isopropyl alcohol.
2. Gently wipe the display screen until clean.

### Internal Components

Internal components that require cleaning are the print head, platen roller and sensor.

1. Turn the printer off.
2. Open the printer cover and remove any cartridge currently in the printer.

**Note:** Make sure the locking lever is in the UNLOCK position. If not, you will not be able to access the print head.

3. Blow debris off of the sensor using a can of compressed air or a lint-free swab.
4. Using a lint-free swab moistened with isopropyl alcohol (or a swab from the Brady PCK-6 Cleaning Kit), gently swab the print head.
5. With the same moistened swab, gently brush the platen roller.

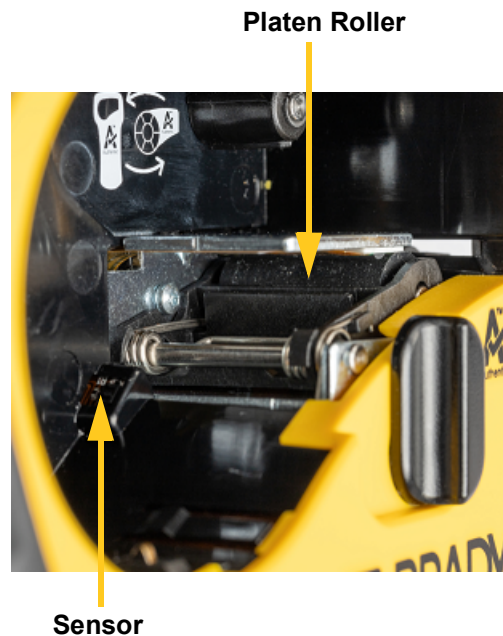

# A Symbols

Symbols for all enabled applications are available for use on any label, regardless of the application/label type in use. See [page 36](#) for information on how to apply symbols to your labels.

## Assorted

### Warning



### Electrical (M210 and Russian only)

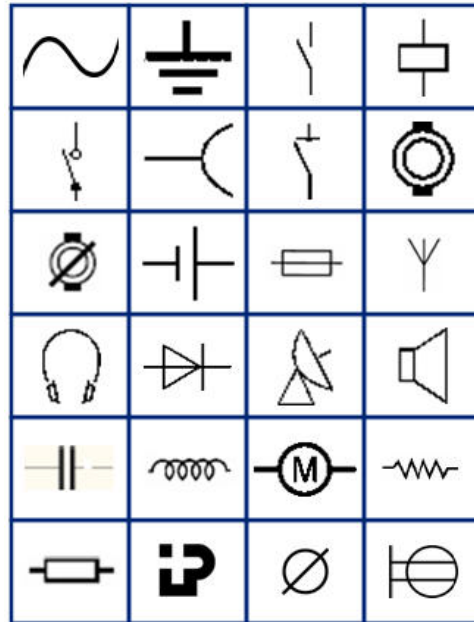

### Home Electrical (M210 and Russian only)



### Arrows

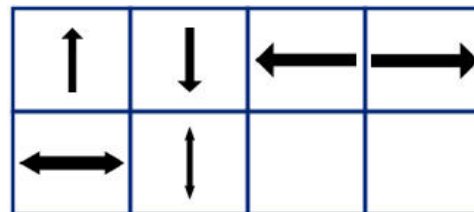

### DataComm (M210 and Russian only)

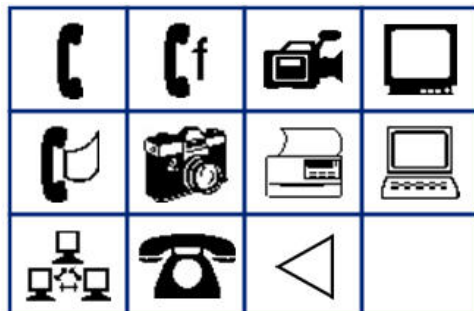

## Miscellaneous

?	¿	¡	;	<	>
[	]	^	{	}	
~	²	£	€	₺	

## Miscellaneous (Russian only)

-	+	=	!	@	#	\$	%	&
*	(	)	:	,	.	"	/	\
°	—	±	'	Ω	Ë	ë	Я	я













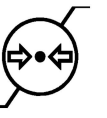











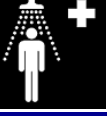















## Greek

**Note:** Available Greek symbols will depend on version of printer.

α	β	Γ	Υ	Δ	δ	ε	ζ
η	Θ	θ	ι	κ	Λ	λ	μ
ν	Ξ	ξ	Π	π	ρ	Σ	ς
σ	τ	υ	Φ	φ	χ	Ψ	ψ
Ω	ω	ά	έ	ή	ί	ό	ύ
ώ							

## Lab

If a symbol cannot print in 6 pt font the “Cannot Fit” error message will display. Change font size to 9 pt. Some symbols will display as  in the editor.

					
					
					
				STERILE	STERILE A
STERILE EO	STERILE R	STERILE !	CONTROL	CONTROL -	CONTROL +
IVD	LOT	REF	SN	IN ANALYSIS	CONFIDENTIAL
					
					
					
					

# B Supported ASCII Characters

## Barcodes

When creating barcodes reference the tables below for supported characters.

### Code 39

A	B	C	D	E	F	G	H	I	J	K	L	M
N	O	P	Q	R	S	T	U	V	W	X	Y	Z
0	1	2	3	4	5	6	7	8	9	(space)		
-	.	\$	/	%	+							

### Code 128

A	B	C	D	E	F	G	H	I	J	K	L	M
N	O	P	Q	R	S	T	U	V	W	X	Y	Z
a	b	c	d	e	f	g	h	i	j	k	l	m
n	o	p	q	r	s	t	u	v	w	x	y	z
0	1	2	3	4	5	6	7	8	9	(space)		
!	"	#	\$	%	&	'	(	)	*	+	,	-
.	/	:	;	<	=	>	?	@	[	\	]	^
_	{		}	'	~							

### Datamatrix and QR Codes

A	B	C	D	E	F	G	H	I	J	K	L	M
N	O	P	Q	R	S	T	U	V	W	X	Y	Z
a	b	c	d	e	f	g	h	i	j	k	l	m
n	o	p	q	r	s	t	u	v	w	x	y	z
0	1	2	3	4	5	6	7	8	9	(space)		
!	"	#	\$	%	&	'	(	)	*	+	,	-
.	/	:	;	<	=	>	?	@	[	\	]	^
_	{		}									

# C Regulatory Compliance

---

## Agency Compliance and Approvals

### United States

#### Note

This equipment has been tested and found to comply with the limits for a Class B digital device, pursuant to part 15 of the FCC Rules. These limits are designed to provide reasonable protection against harmful interference in a residential installation. This equipment generates, and may radiate radio frequency energy and, if not installed and used in accordance with the instructions, may cause harmful interference to radio communications. However, there is no guarantee that interference will not occur in a particular installation. If this equipment does cause harmful interference to radio or television reception, which can be determined by turning the equipment off and on, the user is encouraged to try to correct the interference by one or more of the following measures:

- Reorient or relocate the receiving antenna.
- Increase the separation between the equipment and receiver.
- Connect the equipment into an outlet on a circuit different from that to which the receiver is connected.
- Consult BRADY Technical Support for help.

Changes or modifications not expressly approved by the party responsible for compliance could void the user's authority to operate the equipment.

THIS CLASS B DEVICE COMPLIES WITH PART 15 OF THE FCC RULES. OPERATION IS SUBJECT TO THE FOLLOWING TWO CONDITIONS: (1) THIS DEVICE MAY NOT CAUSE HARMFUL INTERFERENCE, AND (2) THIS DEVICE MUST ACCEPT ANY INTERFERENCE RECEIVED, INCLUDING INTERFERENCE THAT MAY CAUSE UNDESIRE OPERATION.

### Canada

Innovation, Science and Economic Development (ISED)

Canada ICES-003:

CAN ICES-3 (B)/NMB-3(B)



## Europe



### Waste Electrical and Electronic Equipment Directive

In accordance with the European WEEE Directive, this device needs to be recycled in accordance with local regulations.

### RoHS Directive 2011/65/EU, 2015/863/EU

This product is CE marked and complies with the European Union's Directive 2011/65/EU OF THE EUROPEAN PARLIAMENT AND OF THE COUNCIL of 8 June 2011 on the restriction of the use of certain hazardous substances in electrical and electronic equipment.

EU Directive 2015/863 of 31 March 2015 (RoHS 3) amends Annex II to Directive 2011/65/EU of the European Parliament and of the Council as regards the list of restricted substances.

### Batteries Directive 2006/66/EC amended by Battery Directive 2013/56/EU



This product contains a lithium battery. The crossed-out wheeled bin shown to the left is used to indicate 'separate collection' for all batteries and accumulators in accordance with European Directive 2006/66/EC amended by Battery Directive 2013/56/EU. Users of batteries must not dispose of batteries as unsorted municipal waste. This Directive determines the framework for the return and recycling of used batteries and accumulators that are to be collected separately and recycled at end of life. Please dispose of the battery according to your local

regulations.

### Notice to Recyclers

#### To remove the lithium battery pack:

1. Turn the printer over, open the battery compartment door, and remove the battery pack.
2. Dispose of in accordance with local regulations.

#### To remove the lithium coin cell battery:

3. Disassemble printer and locate the lithium coin cell battery located on the main circuit board.
4. Remove the battery from the board and dispose of in accordance with local regulations.

## Turkey

Turkish Ministry of Environment and Forestry

(Directive on the Restriction of the use of certain hazardous substances in electrical and electronic equipment).

Türkiye Cumhuriyeti: EEE Yönetmeliğine Uygundur

## Mexico

Energy Statement:

Consumo de energia en operacion: 3.35 Wh

(Energy consumption in operation mode)

Consumo de energia en modo de espera: 0.1 Wh

(Energy consumption in standby mode)